

personal Hygiene Appliance

maro



Operating Instruction Manual



- *You are kindly requested to read carefully this operation manual for proper use of this appliance with due attention.*

■ Contents

■ Contents	1
■ Technical Specification and Drawing	2
■ Recommended Power Connection	3
■ Security Warning	3
■ Before Installation	7
■ Installation	8
■ Parts List	11
■ Use Manual	12
■ Troubleshooting	15
■ Service Record	17
■ Notes	18

Technical Specification

DI500			
Specification	AC240V,50Hz,65W		
Main Material	Flame-retardant and Anti-aging Plastic		
Seat Temperature Control	Four Grades	1.OFF (Room Temperature)	
		2.Low Level (about33°C),Green Light	
		3.Medium Level (about35°C),Yellow Light , (The default temp when power is on)	
		4.High Level (about 37°C),Red Light	
Night Light and Control	LED Light		
	Short-press the "power" button to turn on/off the night light		
Power Cord	Power cord with leakage protection		
Function	Slow-falling	Seat sensor	Fast Installation and Uninstallation
* Regarding functions, please refer to the label on the back of the product.			

Technical Drawing

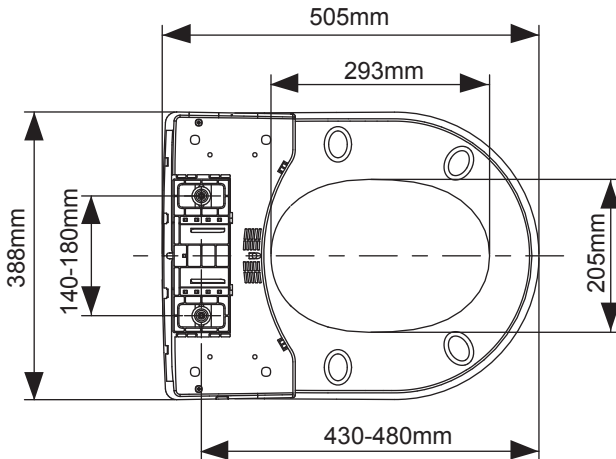

Notes: please refer to the drawing to identify whether the product can match user's ceramic or not.

Recommended Power Connection

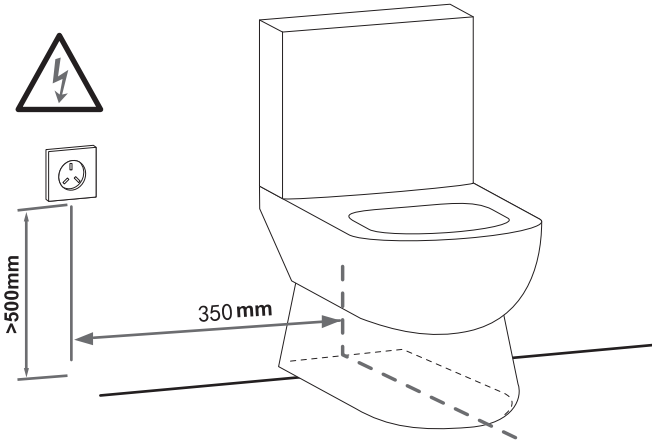

- Power socket can be installed either on the left or on the right of toilet.

Security Warning

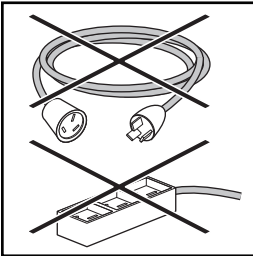

- Use the specified power supply AC 240V,50Hz with leakage protection. Do not put too much loading on the socket. Please do not use an extension cord.

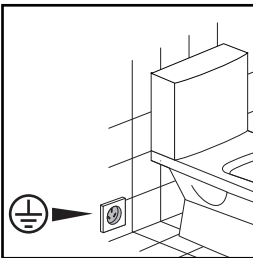

- The product should be safely grounding and make sure the connection meets with the requirements.

Security Warning

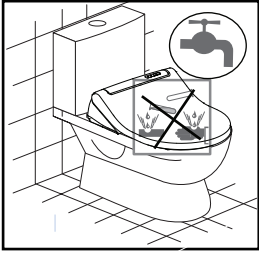

- Do not directly wash the product or put it into water. The product should not be installed quite close to water or in too humid place.

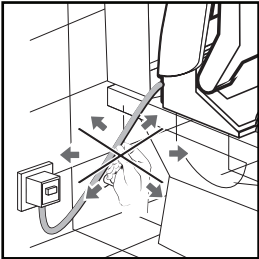

- Do not take rudely of the power plug/power cord, to avoid fire or electric shock.

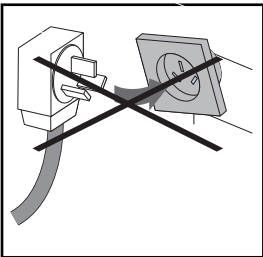

- Do not use loosen socket in case that fire or electric shock should happen.

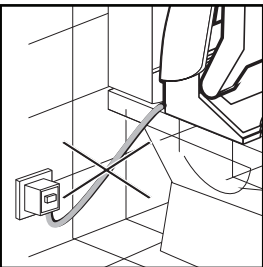

- Please unplug the product before replacing active carbon or cleaning, or else electric shock may happen.

Security Warning

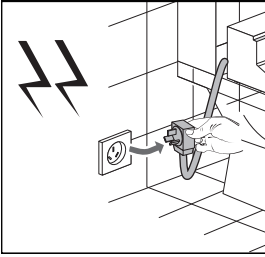

■ Unplug the product if thunder occurs.

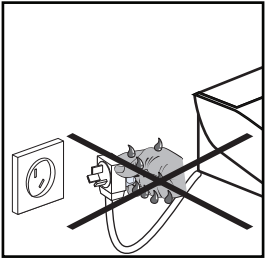

■ Please do not insert or remove the power plug by wet hands.

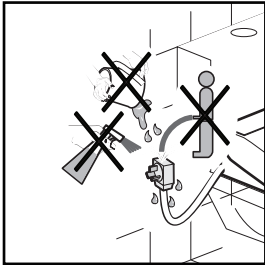

■ Please do not splash water, detergent or urine directly on the product in case electric shock should happen.



■ Do not lean on the cover in case product damage may happen.

Security Warning



- The installation and repairment can only be done by professional servicemen. Users are not allowed to replace the power cord, carbon box or other accessories.

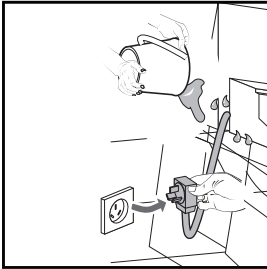

- Please unplug the product when immersed in water.



- Make sure the product has been down to the room temperature for first use in summer.



- Children and elders should be accompanied when using the product.

■ Security Warning



- Do not place stoves or cigarettes besides of the product, and do not throw butt or other inflaming things into the toilet in case fire should happen.

■ Before Installation

1. Do not put the product in a room where the humidity exceeds 90%RH (relative humidity).
2. Use the specified power supply (AC 240V) only, (otherwise it may cause failure or damage to the product)
3. Turn on the power supply only after the installation is completed.
4. Power supply is 240V/50Hz, and the rated power is 65W. Please use suitable power cord and socket.
5. The power cord is 1.8m in length. The electrical outlet should be positioned within the reach of the power plug. Please refer to the technical drawings, recommended power and water supply connection.

When using electrical appliances, especially in the presence of children, users should comply with the following security measures:

1. Do not place the appliance where it can easily fall down or be pulled into the bathtub or sink.
2. Do not place the appliance into water or other liquids.
3. Do not take the product fallen into water. Unplug the power immediately.
4. Do not use it during taking shower.

WARNING:To reduce the risk of incidents, electric shocks, fire, or injuries to users:

1. Please keep a mind while children or patients use it.
2. Do not leave children unattended in the room where the product is in use, the product should not be played by kids.
3. Please preset the seat temperature for users those with physical disabilities, mental retardation, mental disorder, and other disabilities including kids.
4. Use the product only for its intended purpose as described in the manual.

Installation

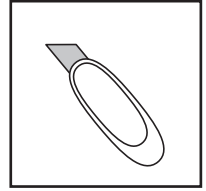
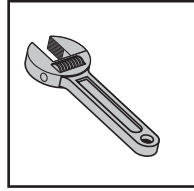
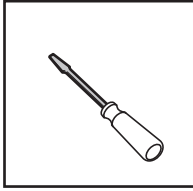
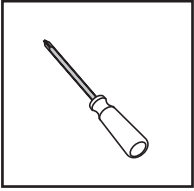

1 Screws

2 Metal Washer

3 Fixation board

4 Rubber nuts

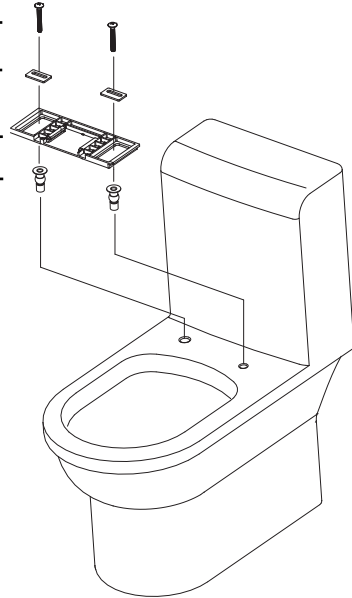

A Remove the original toilet seat and clean the surface of the toilet;

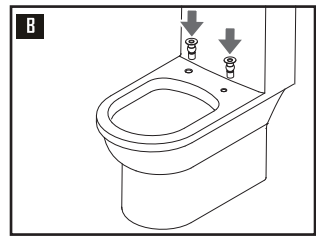

B Press a pair of rubber tubes (No.4) into the fixing holes on the toilet;

Installation

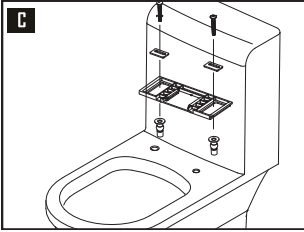

Fix the fixation board (No.3), metal washer(No. 2) and pan head screws on the toilet. The latter part of fixation board should be positioned $490\pm 5\text{mm}$ away from the front of toilet.

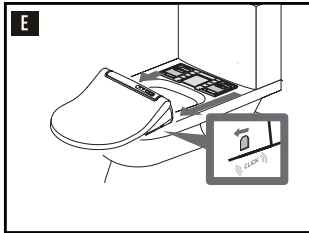

When the intelligent cover needs to be removed, press the button at the right side (refer to the picture), and pull out the cover at the same time;

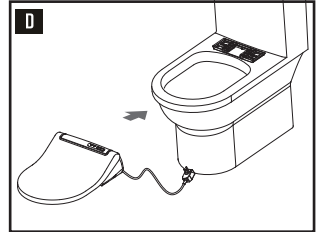

Push the intelligent cover into the slot, then check whether the cover fits the toilet well, if not, replace the position of the fixation board:

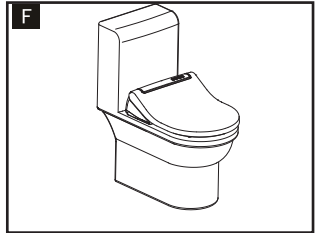

Completed.

Warning

1. Checking the electricity-leakage protection button once of each month.
2. Checking if any leakage happens when the button does not work.
3. Basic security measures should not be replaced by the protection units.
4. Do not connect dangerous electricity wire directly to the ground.
5. The leakage protection plug only protects devices connected with.

EN Installation

EN Warning

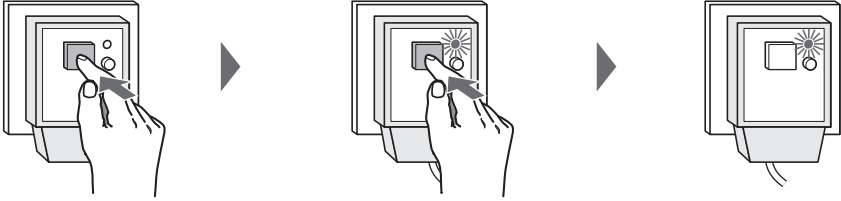

EN Normally, press the power switch, then the indicator light is on, and the power is on.

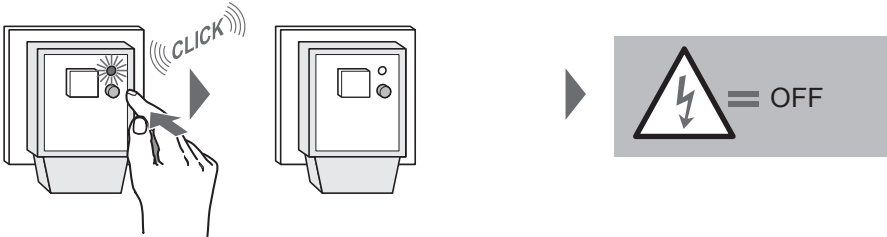

EN Press the leakage test button, if the leakage protection is ok, the light goes off, and the power is off.

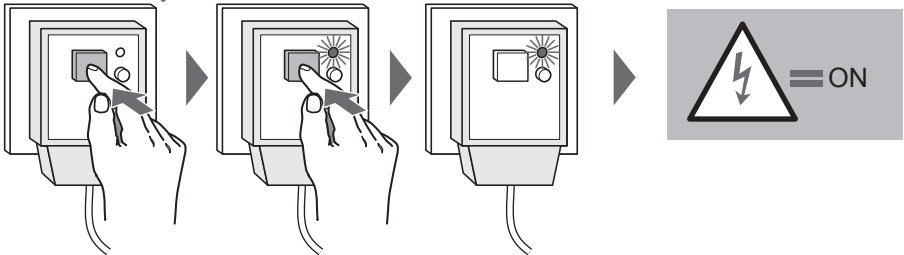

EN Press the leakage test button again, the light goes on, and returns to the normal status.

1. Checking the leakage protection button once of each month.
2. Checking if any leakage happens when the button does not work.
3. Basic security measures should not be replaced by the protection units.
4. Do not connect dangerous electricity wire directly to the ground.
5. The leakage protection plug only protects devices that is connected with.

Parts List

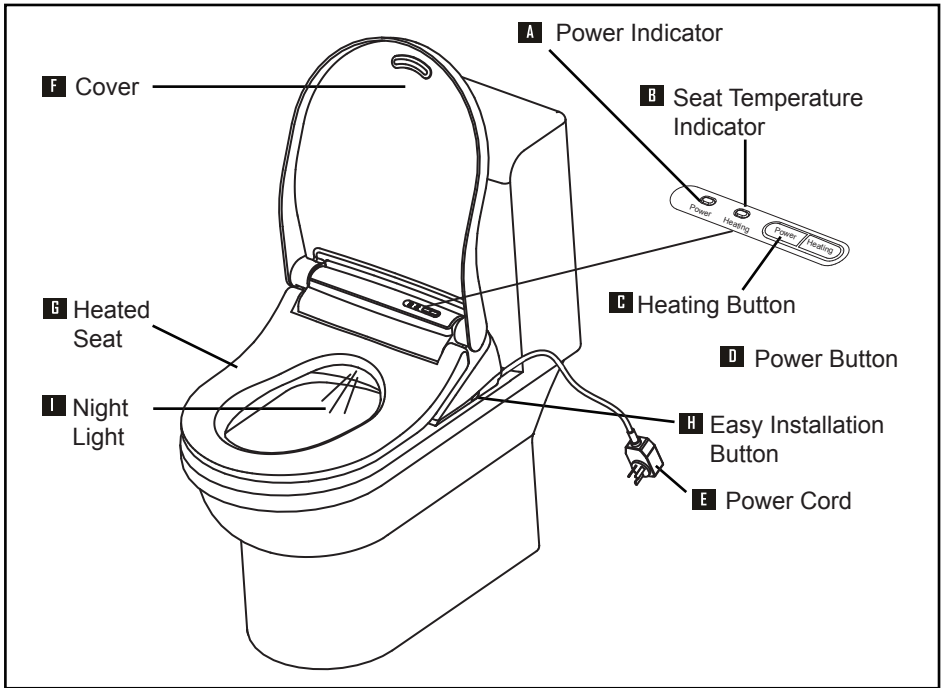

Use Manual

ON-OFF Operation

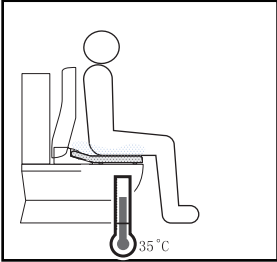

- The product is preset as working status after power connection with 35°C temperature, and night light on.

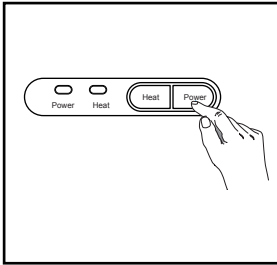

- Keep pressing the power button for more than 3 seconds for power on or off. Keep pressing the power button less than 3 seconds for night light on or off.

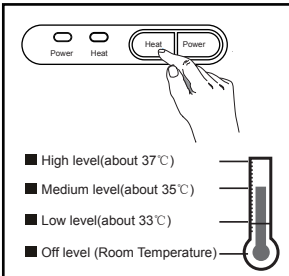

- Press the heat button to turn up or down the seat temperature: off-low level (33°C) –medium level (35°C)–high level (37°C), and it indicates with different colors.

■ Use Manual

■ Easy Installation

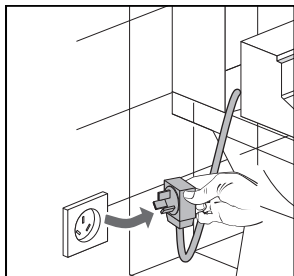

- Unplug the power before cleaning.

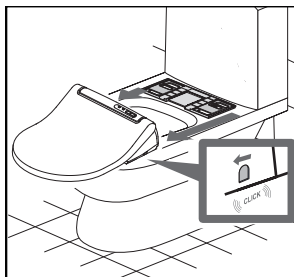

- Press the easy installation button and pull out the product.

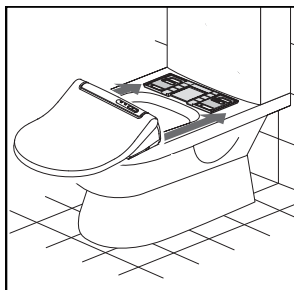

- Push the product into the slot of the fixation board. No need to press the easy installation button again.

Use Manual

Cleaning



- Do not dip the product into water or wash the product directly by water.



- Use wet cotton cloth or sponge to clean the product. Crude cloth is not allowed.



- Mixing regular detergent with enough water to clean the product. Then use soft cotton cloth to clean it.



- Make sure firstly the detergent is not corrosive. If not, test it on a small part of the cover. Clean it enough once using with detergent. Corrosive chemicals or cosmetics are not allowed, in case product damage would occur.

■ Troubleshooting

Frequently asked questions

Please read the following questions carefully, and use it according to the instructions. If the product does not work, contact your local dealers or connect by the service call for help.

Tips!

The following reasons may cause failure of working:

- 1.No power.
- 2.Bad connection of power plug.
- 3.Leakage protection switch of the power plug is off.

If the following phenomenon occurs, cut off the power immediately.

Read carefully the instruction manual. Contact your local dealer or dial the service call for help if needed.

- 1.The heat button keeps flash with green light.
- 2.The heat button keeps flash with red light.
- 3.Leakage protection switches off frequently.

Troubleshooting

Troubleshooting For Main Functions

Trouble		Reason	Solutions
Seat Heating Function	Seat is not warm enough.	Whether the heating function has been switched off or at low level?	Turn up to a higher level.
	Seat is too hot.	Whether the heating function is at high level?	Turn down to a lower level.
Night Light	Light is off.	Light is turned off.	Turn on the light.
	Light is on.	Light is turned on.	Turn off the light.
Indicator and Warning	Heat button flashes with green or red light.	Functional failure.	Cut off the power. Contact with local dealers or dial the service call.
	Leakage protection turns off frequently.	The leakage surpasses the normal range.	Cut off the power. Contact with local dealers or dial the service call.

Significant Indicators and Warning

Trouble		Reason	Solutions
Indicator and alarm function	Heat button flashes with green or red light.	Functional failure	Cut off the power. Contact with local dealers or dial the service call.
	Leakage protection turns off frequently.	The leakage surpasses the normal range.	Cut off the power. Contact with local dealers or dial the service call.

Service Record

Date	Content	Service Department	Serviceman

■ Notes

MARO has the authority for final interpretation of the product. We reserve the right of alterations without prior notice.

maro
