

# TOTO

Instruction Manual

## WASHLET SG



### washlet

TCF403EG/EGE/ESW  
TCF403EG V1  
TCF403G/GE/SW

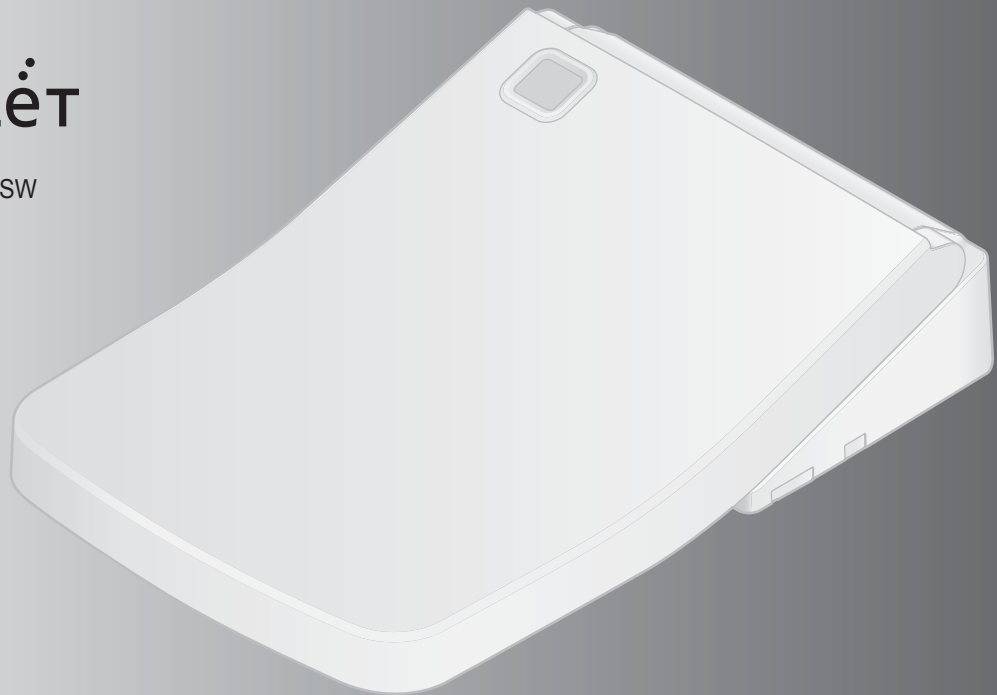

- Thank you for your recent purchase of the TOTO Washlet. Please read the enclosed information to ensure the safe use of your product.
- Be sure to read this Instruction Manual before using your product and keep it in a safe place for future reference.

# What functions are available on your product?

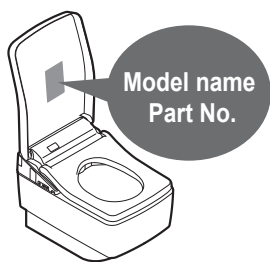

Functions		Model Part No.	WASHLET SG	Ref. Page	
			TCF403		
Basic Functions	Cleansing	Rear cleansing		16	
		Rear soft cleansing	●		
		Front cleansing			
	Changing the washing method	Wand position adjustment		●	16, 17
		Water pressure adjustment			
		Oscillating cleansing			
		Pulsating cleansing			
	Drying	Warm air drying		●	16
Changing the temperature		Temperature adjustment	●	24, 25	
Sanitary Functions	"ewater+" sanitizing	Auto wand cleaning	●	20, 21	
		Auto bowl cleaning			
	Removing odors	Deodorizer	●		
Convenient Functions	Opening and closing	Opening and closing the toilet seat with remote control	●	16	
		Auto open / close (lid)		22, 23	
	Lighting up	Soft light	●		
	Heating the toilet seat	Heated seat	●	—	
	Saving energy	Timer energy saver	●	●	26, 27
Auto energy saver					
Maintenance		Removable toilet lid	●	32	
		Wand cleaning	●	34	

# Cleaning Support Sanitary Toilet



The self-cleaning functions operate automatically.  
(See pages 20 and 21 for details.)

#### As you approach and sit

- A mist is sprayed in the toilet bowl to make it more difficult for dirt to adhere.
- When you sit on the toilet seat, the deodorizer operates.

#### As you stand up

- The wand is cleaned with "ewater+". (The wand extends and then retracts.)

#### As you move away

- "ewater+" is sprayed in the toilet bowl to maintain cleanliness.

## Table of Contents

Safety Precautions .....	4	Introduction
Operational Precautions.....	11	
Parts Names .....	12	
Preparation.....	14	
Basic Operations .....	16	Operation
Automatic Functions (Cleaning Features).....	20	
DEODORIZER, AUTO WAND CLEANING, AUTO BOWL CLEANING, BOWL LIGHT, CLEAN INDICATOR		
Automatic Functions (Convenience Features).....	22	
AUTO OPEN/CLOSE, SOFT LIGHT		
Temperature Adjustment.....	24	
Energy Saver Features.....	26	Maintenance
Power plug / Main unit.....	30	
Gap between the main unit and the toilet lid .....	32	
Deodorizing filter.....	33	
Wand .....	34	
Wand cleaning		
Water filter drain valve.....	35	Reference
Changing Settings .....	36	
What to Do?.....	48	
● If you cannot operate with the remote control .....	48	
● Freeze Damage Prevention .	49	
● Long Periods of Disuse .....	50	
Troubleshooting.....	51	
Specifications .....	57	
Warranty .....	58	
Important User Guidance Information.....	59	

Introduction

Operation



Maintenance

Reference



# Safety Precautions

These precautions are important for safe usage. Be sure to follow them and use the product correctly.



## Symbols and Meanings

	<b>WARNING</b> May result in death or serious injury.
	<b>CAUTION</b> May result in injury or property damage.

The following symbols are used to indicate important safety instructions for the use of the product.

Symbol	Meaning
	This symbol indicates a prohibited use of the product.
	This symbol is used to indicate a required step in the use of this product.

- This product is classified as Class 1 Equipment and must be grounded.
- Install this equipment where the electrical outlet is accessible.
- This appliance is not intended for use by persons (including children) with reduced physical, sensory or mental capabilities, or lack of experience and knowledge, unless they have been given supervision or instruction concerning use of the appliance by a person responsible for their safety. Children should be supervised to ensure that they do not play with the appliance.
- Use the new hose set included with this equipment. Do not reuse an old hose set.

 <b>WARNING</b>	
	<b>Do not touch the power plug or connection of electrical box with wet hands.</b> • Doing so may cause electrical shock.
	<b>Do not get any water or cleaning solution on the main unit or power plug or electrical box.</b> • Doing so may cause fire, electrical shock, heat or short circuit. • Doing so may cause the product to crack resulting in injury or water damage.
	<b>Never disassemble, repair or alter.</b> • Doing so may cause fire, electrical shock, heat or short circuit.
	<b>Do not install the product on moving vehicles such as wheeled vehicles or boats.</b> • Doing so may cause fire, electric shock, short circuit or malfunction. • The toilet seat, toilet lid, main unit or other parts may come loose and fall off, resulting in injury.

## **WARNING**

### **Do not use the Washlet if a malfunction occurs.**

- Always unplug the plug from the outlet.  
Always switch the breaker on the distribution board to OFF. (Concealed power connection type)
- Close the water shutoff valve to stop water supply.  
Possible malfunctions:
  - Water is leaking from a pipe or the main unit.
  - The product is cracked or broken.
  - The product makes a strange noise or emits a strange odor.
  - The product emits smoke.
  - The product is abnormally hot.
  - The toilet seat cushion is out of place.
- Continued use after malfunction could cause a fire, electric shock, heat, short circuit, injury or water damage.

### **Only use tap water or potable well water (underground water).**

#### **Do not use seawater.**

- Doing so may cause irritation to the skin and malfunction.

### **Do not touch the power plug or electrical box during thunderstorms.**

- Doing so may cause electrical shock.

### **Do not allow the water supply hose to touch the power plug or outlet or electrical box.**

- Doing so may cause condensation resulting in a fire, electrical shock, heat or a short.

### **Do not do anything that may damage the power cord, power plug.**

Do not strike, yank, twist, excessively bend, damage, alter, or heat the electrical cords. Also, do not place anything heavy on, bind or pinch the electrical cords.

- Using a damaged electrical cord may result in a fire, electrical shock, heat or short.

### **Do not use a loose or faulty electrical outlet.** (Except concealed power connection type)

- Doing so may cause fire or short circuit.

### **Do not use any outlet or wiring equipment beyond its specified rating.**

(Except concealed power connection type)

- Plugging too many plugs into the same outlet, for example using outlet splitters, can cause fire due to heat.

### **Do not use any power supply other than the one specified.**

AC 220V - 240V, 50Hz

- Doing so may cause fire or excessive heat.



# Safety Precautions (Continued)

## **WARNING**



### **To reduce the danger of burns, death from electric shock, fire or other human injury:**

- Never operate this product if it has a damaged cord or plug, if it is not working properly, if it has been dropped or damaged, or if it has been dropped in water. Return the product to TOTO Europe GmbH for examination and repair.
- Never block the air openings of the product or place it on a soft surface, such as a bed or a couch, where the air openings could be blocked. Keep the air openings free of lint, hair or a similar material.
- Never use it while sleepy or drowsy.
- Never drop or insert anything into any opening or hose.
- Do not use it outdoors where aerosol (spray) products are being used or where oxygen is being administered.

### **Do not stick a finger or anything else into the warm air outlet.**

Do not place anything on the warm air outlet or drape clothes over it.

- Doing so may cause burns, electrical shock or malfunction.

### **Keep cigarettes and other open flames away from the product.**

- Failure to do so may cause fire.



### **Beware of irritation or burn**

- Improper use of the toilet seat may cause irritation or burn.

When sitting for a long time on the toilet seat, switch the toilet seat temperature adjustment to "OFF".

When any of the following persons use a heated seat or warm air drying, someone should switch the toilet seat temperature adjustment to "OFF" and switch the drying air temperature to "Low".

- Young children, the aged and other users unable to set the temperature appropriately themselves
- The ill, physically disabled and others who do not have freedom of movement.
- Those using any medicines that cause drowsiness (sleeping or cold medicine), those who have been drinking heavily, anyone severely fatigued and anyone else liable to fall asleep.

### **To reduce the danger of burns, death from electric shock, fire or other human injury:**

- Close supervision is necessary when this product is used by or near children or invalids.
- Use this product only for its intended use as described in this manual. Do not use accessories not recommended by the manufacturer.
- Keep the cord away from heated surfaces.
- Connect this product to a properly grounded outlet only.
- The tank should only be filled with water.

## **WARNING**

**This is an electrical product. Do not install it anywhere water is likely to get on the product or anywhere with humidity high enough that water is likely to form on the surface of this product. When using the product in a bathroom, install a fan or ventilation port and ensure good air flow through the bathroom.**

- Failure to do so may cause fire or electrical shock.

**Always connect the Washlet to the cold water supply.**

- Connecting to hot water supply may result in burns and equipment damage.

**Check that an appropriate ground is installed.**

- If the ground is not installed, if there is a breakdown or electrical current leak, the lack of a ground could cause electrical shock.

For the ground, use copper wire with a ground resistance of 100  $\Omega$  max. and a diameter of 1.6 mm min.

\* If there is no ground installed, ask the contractor who did the installation to install the ground.

**Make sure that a properly grounded (3 prong) outlet has been installed.**

- Failure to install a grounded outlet could cause electrical shock in the event of a malfunction or short circuit.

**Check that the outlet for electrical power is as follows.**

- Failure to do so may cause fire or electrical shock.

a. Apply a current to the outlet (or device) through a differential residual current device whose release current does not exceed 30 mA.

b. Install the outlet (or device) and its wiring plug at least 0.60 m away from the outside of the shower tub or bathtub.

\* Check that the wiring in a. and b. above is complete. If the wiring has not been completed, ask the contractor who did the installation to do it.

**Insert the power plug securely into the outlet.**

**Check that the power cord is connected.** (Concealed power connection type)

- Failure to do so may cause fire, heat or short circuit.

\* When installing this product, observe the local laws and regulations regarding installation.

**To unplug, hold the plug, not the cord.** (Except concealed power connection type)

Do not unplug by pulling the cord.

- Pulling on the cord may cause damage and result in fire or heat.

**If the electric cord is damaged, avoid danger by having the manufacturer's repair department or equivalent specialist replace it.**



# Safety Precautions (Continued)



## WARNING



**Always disconnect the power plug from the outlet before cleaning, maintenance or inspection.**

**Always switch the breaker on the distribution board to OFF.** (Concealed power connection type)

- Failure to do so may cause electrical shock or malfunction.

\* Except when using "Wand cleaning"

**Periodically remove dust and dirt from the power plug and make sure it is securely plugged into the wall outlet.** (Except concealed power connection type)

- Failure to do so may cause fire, heat or short circuit.

Pull the plug out from the outlet and wipe clean with a dry cloth.



## CAUTION

### **Do not use the product if the main unit is unstable.**

- Doing so may cause the main unit to come loose and fall, resulting in injury.
- \* If there is backlash in the main unit, consult the installer, seller or the contact listed on the back cover of this manual.

### **If the product is damaged, do not touch the damaged section.**

- Doing so may cause electrical shock or injury.
- Replace it immediately.

### **Do not apply strong force, mechanical shock, step on or stand on the toilet seat, toilet lid or main unit. Also do not place any heavy object on the toilet seat, toilet lid or main unit.**

- Doing so may cause cracking or cause the main unit to come loose and fall, resulting in injury.
- Doing so may damage the product and cause injury or water damage.

### **Do not lift up this product by the toilet seat or lid.**

### **Do not raise the toilet seat or lid while objects are resting on top of the toilet.**

- Doing so may cause the main unit to come loose and fall, resulting in injury.

### **To reduce the danger of death from electric shock:**

- Do not use while bathing.
  - Do not place or store the product where it could fall or be pulled into a tub or sink.
  - Do not put in or drop into water or other liquid.
  - Do not try to recover the product if it has fallen into water. Unplug it immediately.
- Switch the breaker on the distribution board to OFF. (Concealed power connection type)



### **When cleaning or maintaining the plastic parts (main unit etc.) or the water supply hose, use a kitchen cleaner diluted with water. Do not use any of the following.**

Toilet cleaner, household cleaner, benzene, paint thinner, powdered cleanser or nylon scrubbing pads.

- These items may damage or crack the plastic and cause injury or malfunction.
- These items could damage the water supply hose and cause a water leak.

### **To prevent a sudden water leak, do not remove the water filter drain valve when the shutoff valve is open.**

- Doing so will cause water to spurt out.
- (Refer to Page 35 for instructions on cleaning the water filter drain valve.)

### **Do not fold or crush the water supply hose; do not damage by cutting with a sharp object.**

- Doing so may cause water leaks.

# Safety Precautions (Continued)

## CAUTION



**If a water leak should occur, always close the shutoff valve.**

**When the ambient temperature is likely to drop to 0°C or lower, prevent damage to the pipes and hoses due to freezing.**

- Frozen water pipes could cause the main unit and the pipes to break, resulting in a water leak.
- Regulate the room temperature to prevent the pipes and hoses from freezing during cold months.
- Drain the water.

**When not using the Washlet over an extended period of time, drain the water out of the main unit and the water supply hose after closing the water shutoff valve, and pull the electrical plug from the outlet.**

**Switch the breaker on the distribution board to OFF.** (Concealed power connection type)

- When using the product again, allow the product to refill with water first. Otherwise, the water in the tank might become contaminated and cause skin inflammation or other problems. (Refer to Page 50 for instructions on replenishing the water.)
- Leaving the power on may cause fire or heat.

**When installing the water filter drain valve, make sure that it is securely tightened in its proper position.**

- Failure to securely tighten it may cause a water leaks.

# Operational Precautions

## ■ For prevention of malfunctions

- Do not block the body sensor or the remote control transmitter or receiver.

### < About the body sensors >

Two types of body sensors are used.

- Body sensor A detects changes in heat.
  - Detection may be difficult when the room temperature exceeds 30°C, such as in the summertime.
  - When sunlight is directly on the sensor area or a heater is used in the bathroom, the sensor may detect incorrectly due to the heat, resulting in the automatic operation of functions such as auto lid opening and closing.
  - When the bathroom door is open, the sensor may detect people who pass to the front or side of the toilet.
- Body sensor B detects when someone stands in front of the toilet bowl.
  - Body sensor B emits an infrared beam as shown in the figure. When someone moves into the line of this infrared beam, the sensor detects the person.

\*Detection by the sensor may be difficult when the toilet is used by someone small, such as a child.

Body sensor A



Body sensor B



### < About the seat switch >

- When you sit on the toilet seat, the seat switch turns ON, enabling you to use various features. (A click sound is heard when the seat switch is ACTIVATED.)

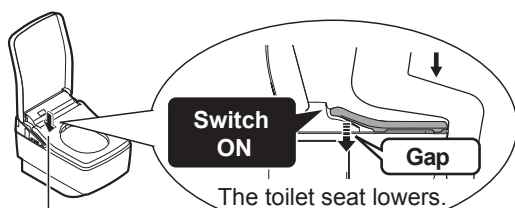

Seat switch (Built-in)

- Sit back on the toilet seat.
  - The seat switch will not turn on unless you sit on the seat properly.



#### Note

- When a child uses the Washlet, the seat switch may not be ACTIVATED by their light body weight.
- Since the toilet seat is designed to move up and down, a clearance is provided between the toilet seat cushion and the toilet bowl.

## ■ For prevention of damage

- Wipe plastic areas such as the main unit and remote control with a soft, wet cloth.
- Do not lean against the toilet lid.

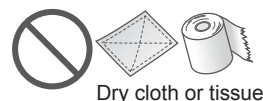

## ■ Problem Prevention

- Disconnect the power plug if there is a risk of lightning. Switch the breaker on the distribution board to OFF. (Concealed power connection type)
- A toilet seat cover or a toilet lid cover cannot be used. (The body sensors or seat switch may not function properly.)



- Do not urinate on the main unit, toilet seat or wand. (Doing so may cause pink or brown stains or malfunction.)
- Do not apply strong forces to the control panel of the remote control.
- When using a toilet cleaner to clean the toilet, wash it off within 3 minutes and leave the toilet seat and toilet lid open. Wipe off any cleaner that remains on the toilet bowl. (If vapor from a toilet bowl cleaner enters the main unit, it may cause a malfunction.)
- Do not expose to direct sunlight. (Doing so may cause changes in color, irregular heated seat temperature, remote control malfunction or Washlet malfunction due to the change in temperature.)
- Use radios, etc. away from the Washlet. (The Washlet could cause interference with the radio signal.)
- If you use a booster seat for infants or a soft highchair, remove it after use. (Keeping it installed may prevent some of the functions from being used.)
- Do not apply force to the remote control. (May cause malfunction.) To prevent the remote control from being dropped, set it in the hanger when you are not using it. Be careful not to expose it to water.

### About rear cleansing, rear soft cleansing and front cleansing

- **These functions wash away waste and dirt from a localized area of your body.**
- **Do not cleanse too much or for too long.** Doing so may wash away normal bacteria, upsetting the balance of bacteria inside your body.
- **People who are receiving medical treatment or therapy in this localized area should consult their doctor before use.**

# Parts Names

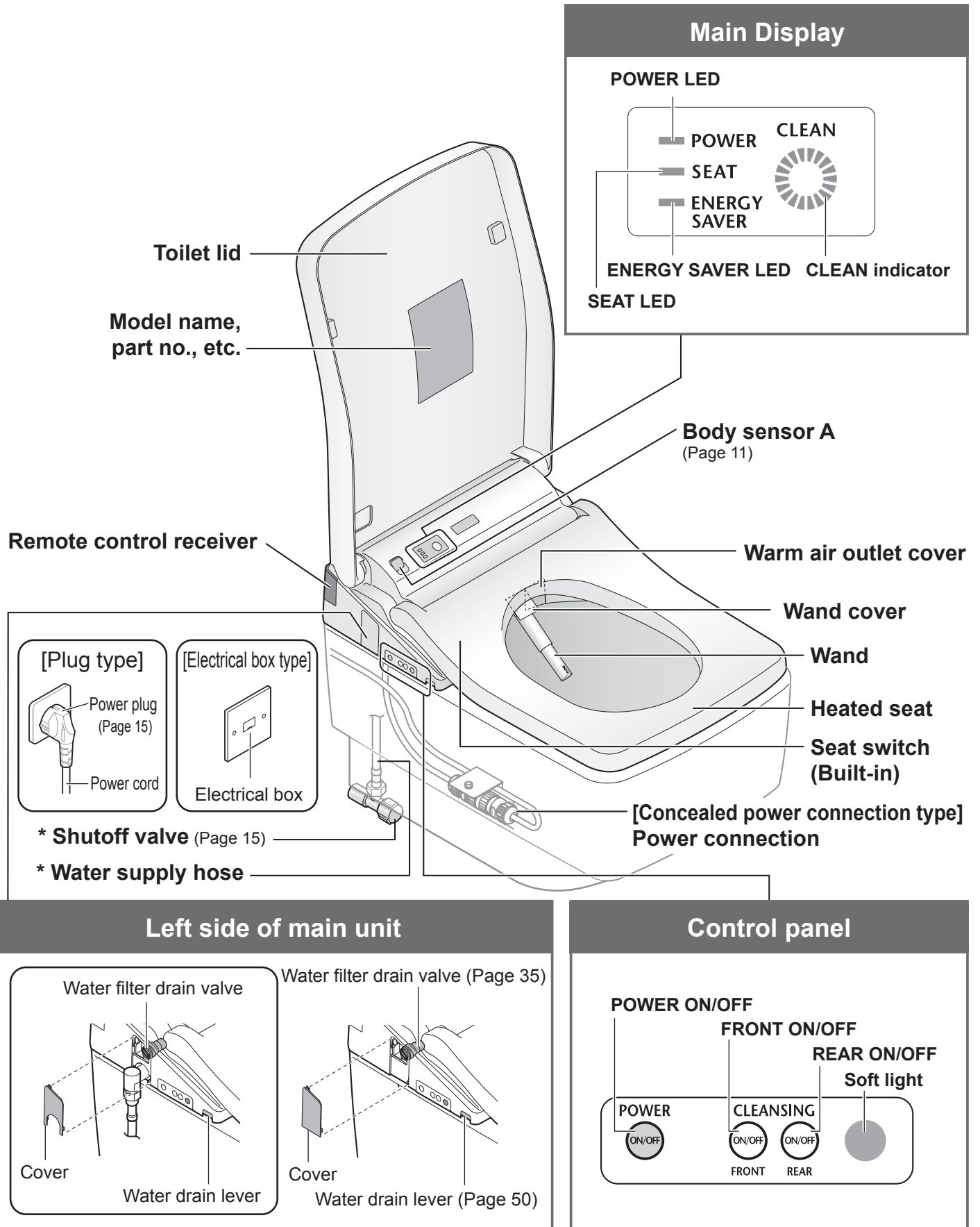

\* Locations of the shutoff valve and the water supply hose may vary depending on the model.

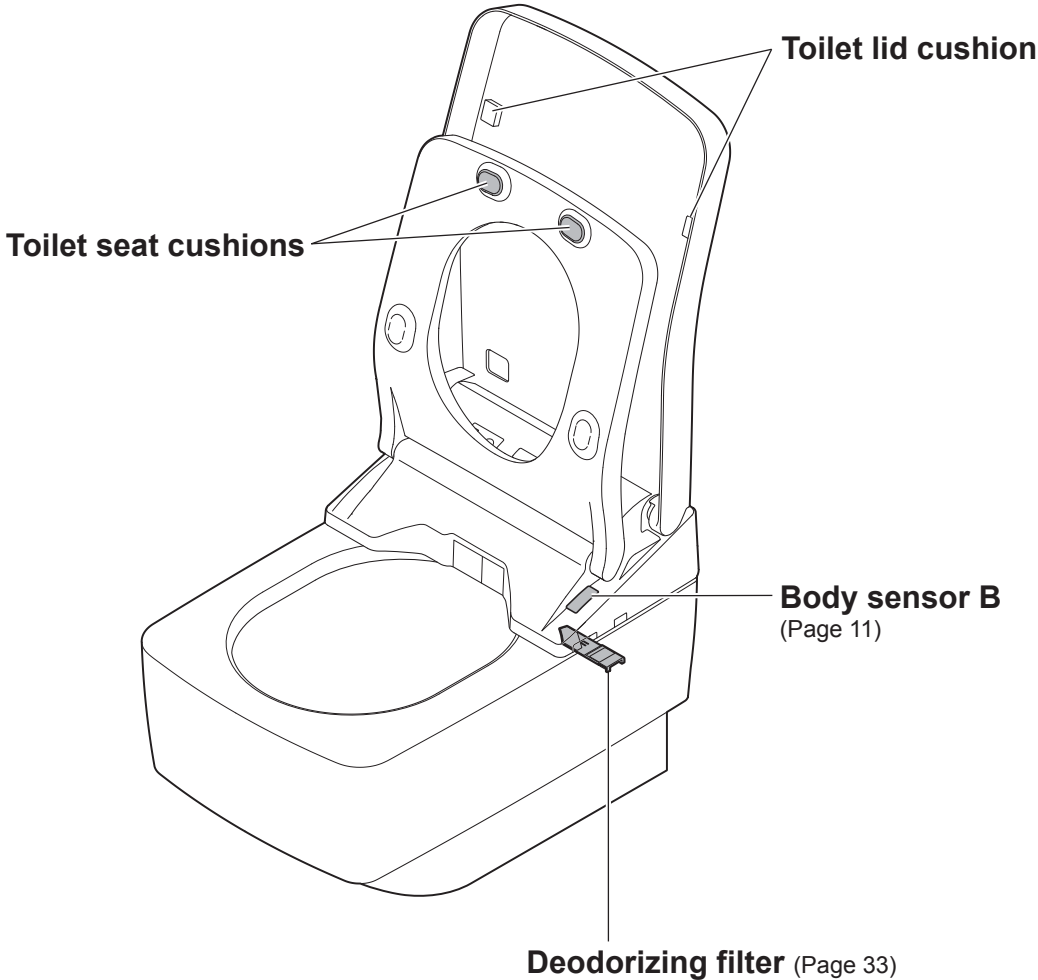
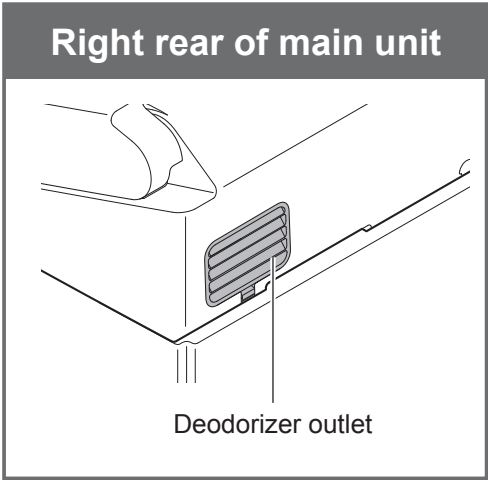

# Preparation

## Using the Product for the First Time

### 1. Insert the battery

- 1 Remove the remote control from the hanger.

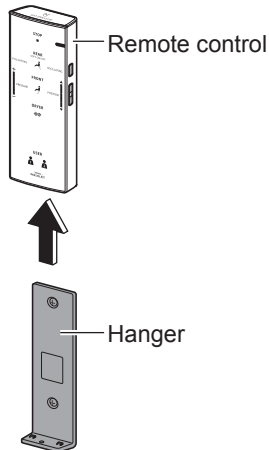

- 2 Open the battery cover and insert two AA batteries.

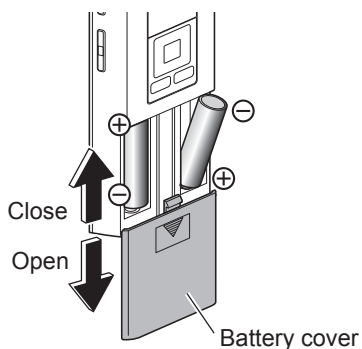

- When batteries are properly inserted, temperature levels appear on the display of the remote control (back side).
- The display goes out when no button on the remote control is pressed for 5 minutes or more.

- 3 Mount the remote control in the hanger.

#### ■ About the batteries

- Use dry cell, alkaline batteries. Follow the instructions below to prevent the batteries from rupturing or leaking fluid.
- When replacing the batteries, use new batteries of the same brand.
- If you will not be using the remote control for a long time, remove the batteries.
- Do not use rechargeable batteries.

### If the remote control is secured (for anti theft)

- 1 Remove the screw from the remote control fixture.

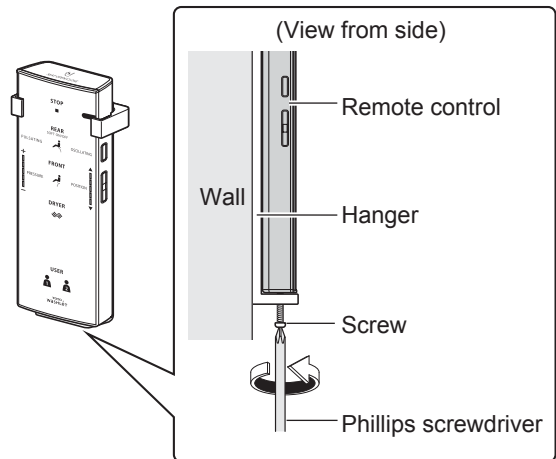

- 2 Remove the remote control from the hanger.

- To secure the remote control again  
Tighten the screw.  
(Overtightening may cause damage to parts such as the hanger)

## 2. Turn on the power

- 1** Insert the power plug.  
Switch the breaker on the distribution board to ON.  
(Concealed power connection type)

- The wand extends and then retracts.

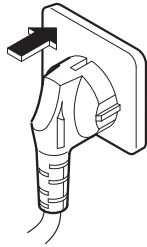

- 2** Check that the POWER LED on the main display is lit up.

- If it does not light up, press [POWER ON/OFF] to light it up.

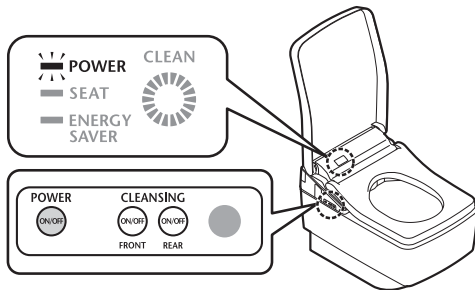

## 3. Open the shutoff valve

- 1** Fully open the shutoff valve.

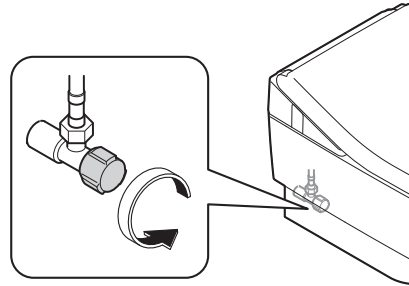

## To turn the power "OFF"

### POWER



Press [POWER ON/OFF] to turn the power off.

- The POWER LED goes off.

# Basic Operations

Press a button on the remote control; a beep sounds when the main unit receives the signal.

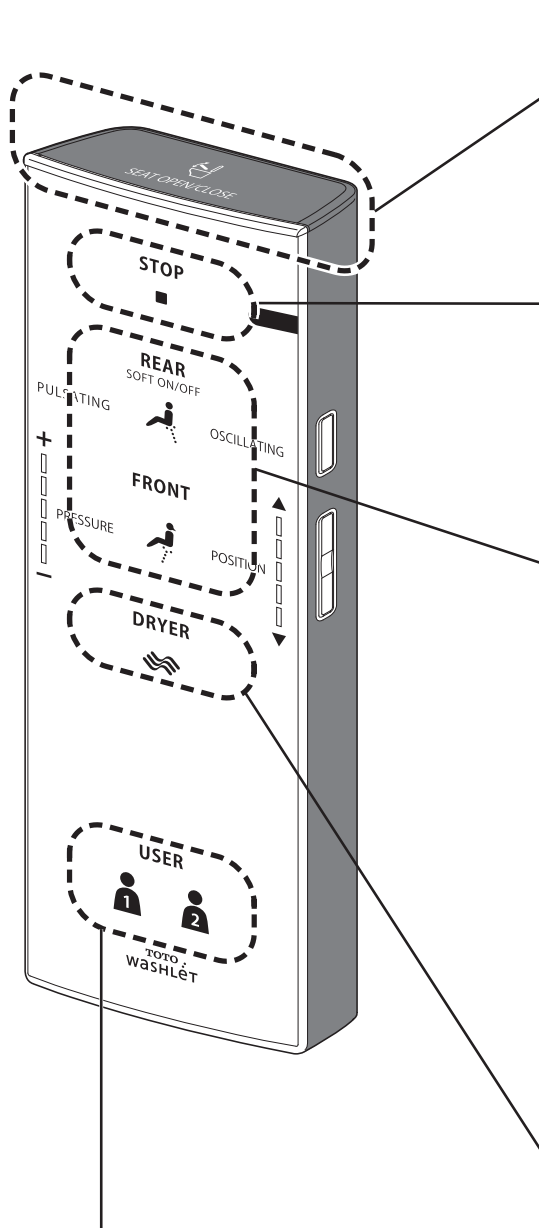

The diagram shows a vertical remote control with several buttons and indicators. The buttons are labeled: SEAT OPEN/CLOSE (top), STOP, REAR SOFT ON/OFF, FRONT, DRYER, and USER (with two user icons). There are also indicators for PULSATING, OSCILLATING, PRESSURE, and POSITION.

### Opening and closing

**[SEAT OPEN/CLOSE]**  
Opens and closes the toilet seat.

### Stopping

**[STOP]**  
Stops the operation.

### Cleansing

**[REAR]**  
Cleanses your rear.

-----

**[SOFT]**  
Washes your rear with mild water pressure.

\*The mode changes between [SOFT] (Flickering) and [REAR] (Lit) each time the button is pressed.

-----

**[FRONT]**  
Serves as a bidet for ladies.

### Drying

**[DRYER]**  
Dries your rear.

## Personal setting lock



### [USER1] / [USER2]

You can store your preferred wand position, water pressure and water temperature a setting.

To store a setting

While cleansing is in progress, set your preferred wand position, water pressure, and warm water temperature, and then press and hold [USER 1] or [USER 2] for 2 seconds or longer.

To use

Press [USER 1] or [USER 2], and then press the button for the cleansing you want to use.

\*The wand position and water pressure lamps will light up for about 10 seconds in their set positions, and the water temperature display switches.



- Functions that operate when a button is pressed during "REAR", "SOFT" or "FRONT" cleansing.

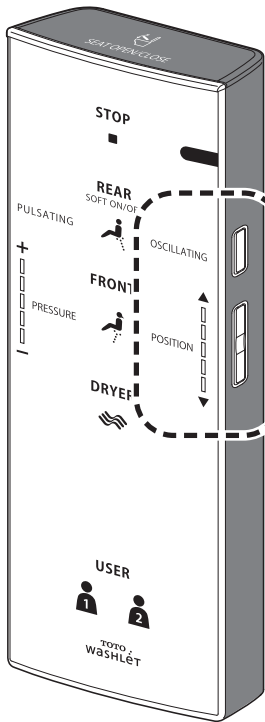

**[OSCILLATING]**

- The wand moves back and forth to wash your rear thoroughly.
- The setting changes between "ON" and "OFF" each time the button is pressed.

---

**[POSITION]**

- The wand position can be adjusted to the front or rear.
- ("▲": Moves to the front, "▼": Moves to the rear)

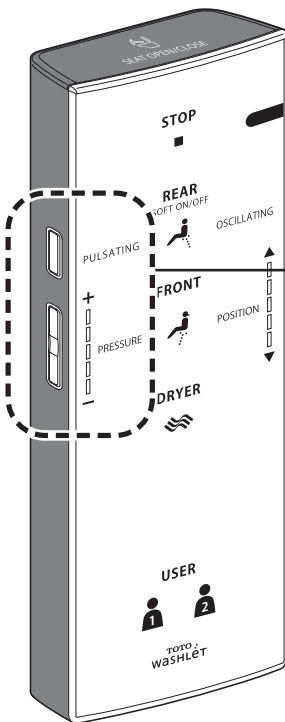

**[PULSATING]**

- Washes with the water pressure pulsating between soft and strong.
- The setting changes between "ON" and "OFF" each time the button is pressed.

---

**[PRESSURE]**

The water pressure strength can be adjusted for cleansing functions such as REAR. ("-" : Softer, "+" : Stronger)

**Note**

- Sitting back on the toilet seat makes it easier to adjust the wand position and to reduce splashing.

# Basic Operations

## About the Menu Screen

This section is an overview of the settings that can be configured with the remote control.

- See the corresponding pages for the detailed descriptions.

### Remote control back side

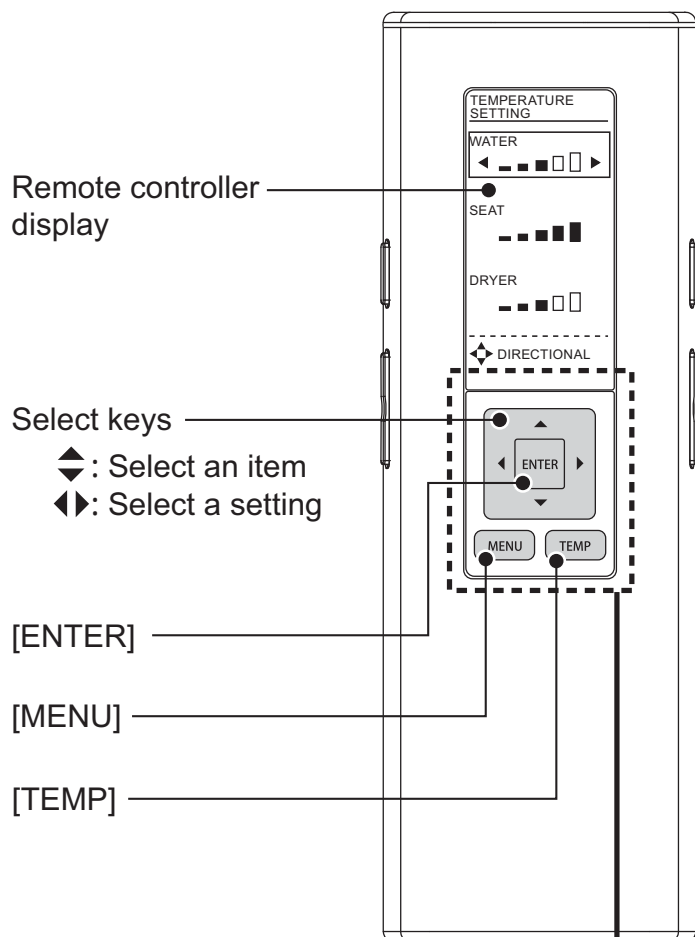

Press [MENU] to display the menu screen.



### SETTING LOCK

You can lock the settings so that you do not mistakenly operate the rear buttons while using the remote control.

How to Set (Page 46)

Display screen during setting lock





**Level 1**                      **Level 2**                      **Level 3**

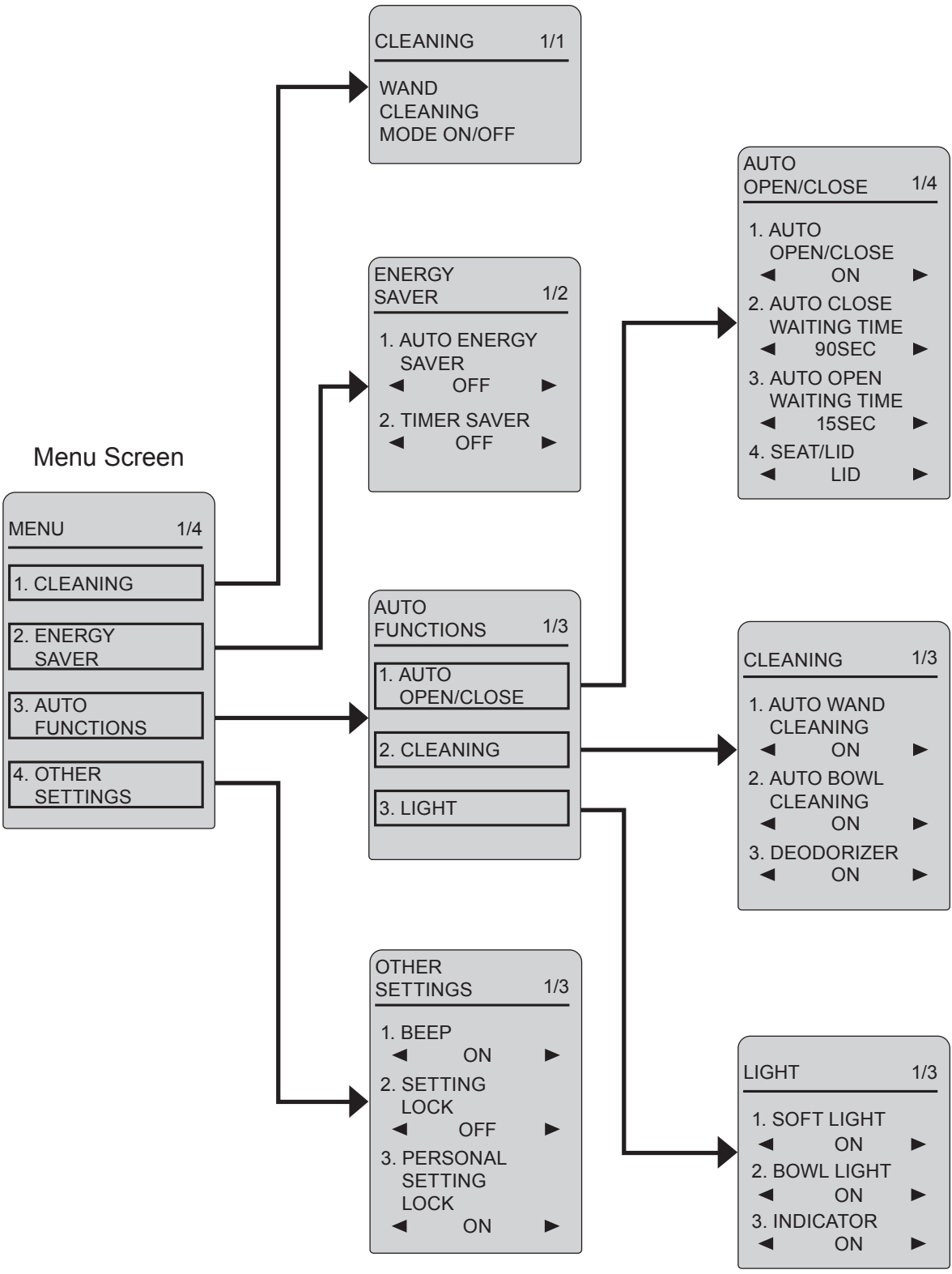

**Operation**

# Automatic Functions

## Cleaning Features

"ewater+" \*1 is used automatically to clean the wand and toilet bowl.



### DEODORIZER

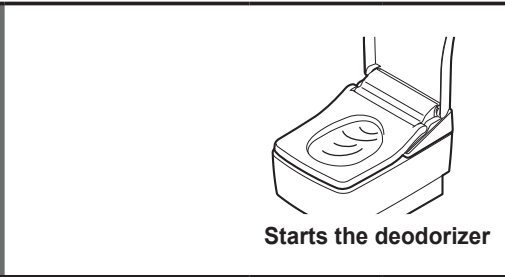

**Deodorizer stops**  
→It stops after about 2 minutes

### Clean the wand automatically with "ewater+" \*1 AUTO WAND CLEANING

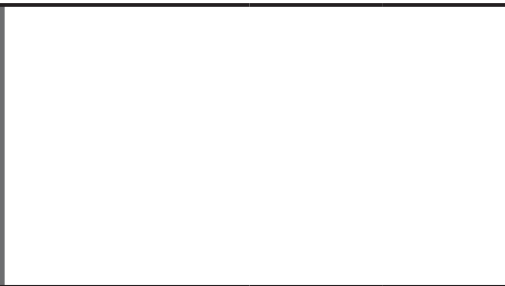

**Cleans the wand automatically**  
→After about 25 seconds, the wand extends and "ewater+" \*1 comes out from the base of the wand (Only when the cleansing functions are used)

### Sanitize the toilet bowl with "ewater+" \*1 AUTO BOWL CLEANING

**Pre-mist**  
(A mist is sprayed inside the toilet bowl to make it more difficult for dirt to adhere)

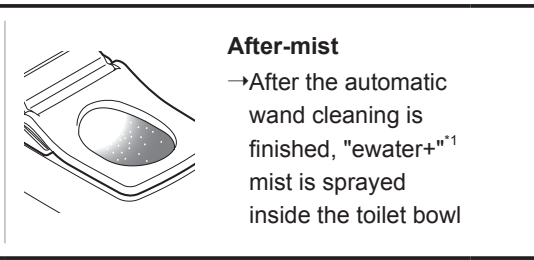

### BOWL LIGHT

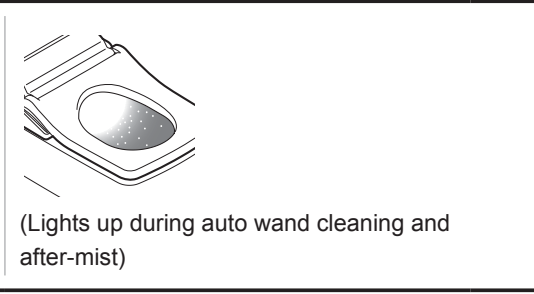
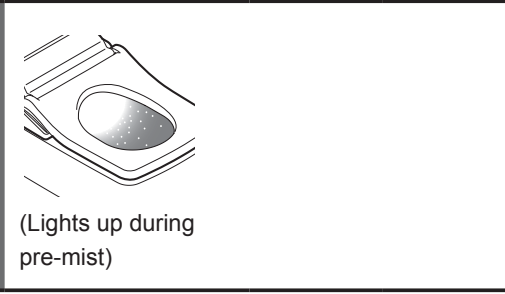

### INDICATOR

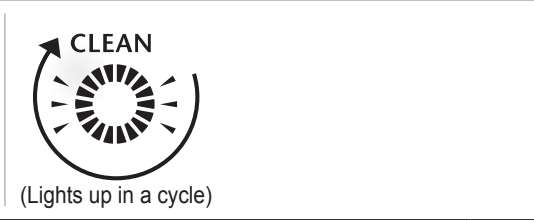
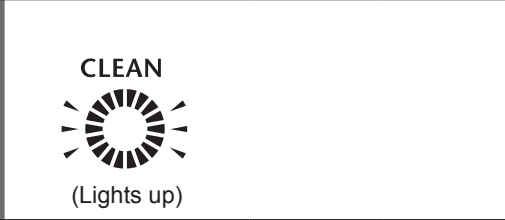

\*2 Water comes out from around the wand.

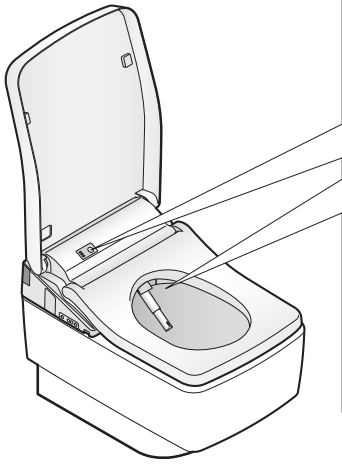

## Support Cleaning

### ■ CLEAN indicator

Lights to show that the "clean" functions are operating.



### ■ Bowl light

Lights to show that auto bowl cleaning and auto wand cleaning are operating.

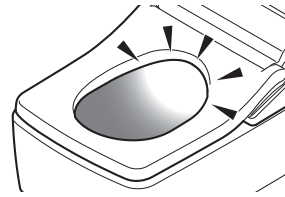

### ■ Note

### ■ Changing settings

	<ul style="list-style-type: none"> <li>• DEODORIZER ON/OFF (Page 42)</li> </ul>
<ul style="list-style-type: none"> <li>• When the cleansing functions have not been used in 8 hours, the wand is cleaned automatically. (Water comes out from near the wand cover.)</li> </ul>	<ul style="list-style-type: none"> <li>• AUTO WAND CLEANING ON/OFF (Page 42)</li> </ul>
<ul style="list-style-type: none"> <li>• The pre-mist and after-mist are not sprayed if the toilet seat is open.</li> <li>• The pre-mist does not work for about 90 sec. after some one has used it.</li> <li>• When the cleansing feature is not used for about 8 hours, mist is sprayed on the toilet bowl automatically.</li> </ul>	<ul style="list-style-type: none"> <li>• AUTO BOWL CLEANING ON/OFF (Page 42)</li> </ul>
	<ul style="list-style-type: none"> <li>• BOWL LIGHT ON/OFF (Page 44)</li> </ul>
<ul style="list-style-type: none"> <li>• Lights up continuously or in a cycle when "Auto wand cleaning", "Auto bowl cleaning" or "Deodorizer" is operating. (Lights up in a cycle only when the seat has been used.)</li> </ul>	<ul style="list-style-type: none"> <li>• INDICATOR ON/OFF (Page 44)</li> </ul>

### If dirt adheres...

#### ■ If dirt adheres to the wand during use, you can extend the wand to clean it.

- Cleaning the wand (Page 34)

#### \*1 What is meant by "ewater+"/>

This water containing hypochlorous acid generated from chloride ions in tap water, is widely used for cleaning and disinfecting items such as food, utensils and baby bottles.

- Well water may not deliver the required effect. (Because the level of chloride ions is low.)
- Clean, sterile water helps to minimize dirty surfaces, but does not make cleaning unnecessary.
- The effect and duration vary depending on the usage environment and conditions.

# Automatic Functions

## Convenience Features

Various automatic functions are available, such as a toilet lid that opens and closes automatically.

- Operation under the initial settings is described below.

### As you approach

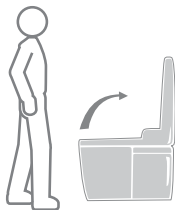

### As you sit



### As you stand up

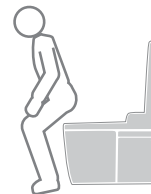

Opening the toilet lid automatically  
**AUTO OPEN/  
 CLOSE**

#### When using the toilet seat

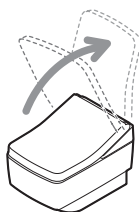

**Toilet lid opens**

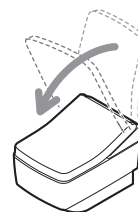

**Toilet lid closes**  
 (About 90 seconds after you stand up from the toilet seat.)

#### When standing-up to urinate

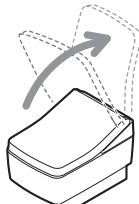

**Toilet lid opens**

\*Open the toilet seat with the remote control.



Lighting up the inside of the bathroom with a soft light  
**SOFT LIGHT**

#### Lights up in middle mode

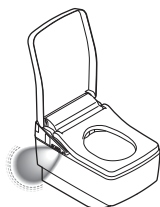

#### Lights up in high mode

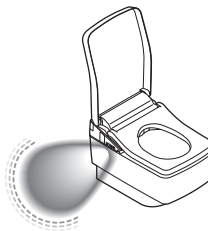

#### Lights up in middle mode (About 90 seconds)

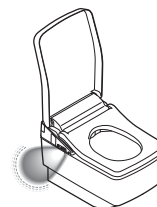

## As you move away

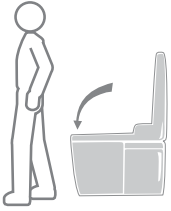

### Note

### Changing settings

- Detection by the body sensor may be difficult when the room temperature exceeds 30°C. (Open by hands.)
- When the toilet lid is closed with the remote control or by hand, it cannot open automatically for about 15 seconds. (Open and close manually.)
- When you do not sit on the toilet seat, or when you sit on it or stand in front of the toilet bowl briefly, it takes about 5 minutes before the lid close automatically.

- AUTO OPEN/CLOSE ON/OFF (Page 38)
- AUTO CLOSE DELAY (25 seconds or 90 seconds) (Page 38)
- AUTO OPEN DELAY (15 seconds, 30 seconds or 90 seconds) (Page 40)
- Automatically opening the toilet lid or both the toilet seat and toilet lid (Page 40)

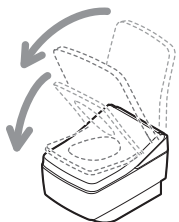

### The toilet lid and toilet seat close

(About 90 seconds after the user has moved about 30 cm away from the toilet seat.)

### Lights up in low mode

(Goes out after about 5 seconds.)



- SOFT LIGHT ON/OFF (Page 44)

# Temperature Adjustment

Warm Water / Toilet Seat / Drying

You can adjust the temperature levels or turn the settings to "OFF".

**1**  Press [TEMP].

**2**  Use  to select the item you want to set.

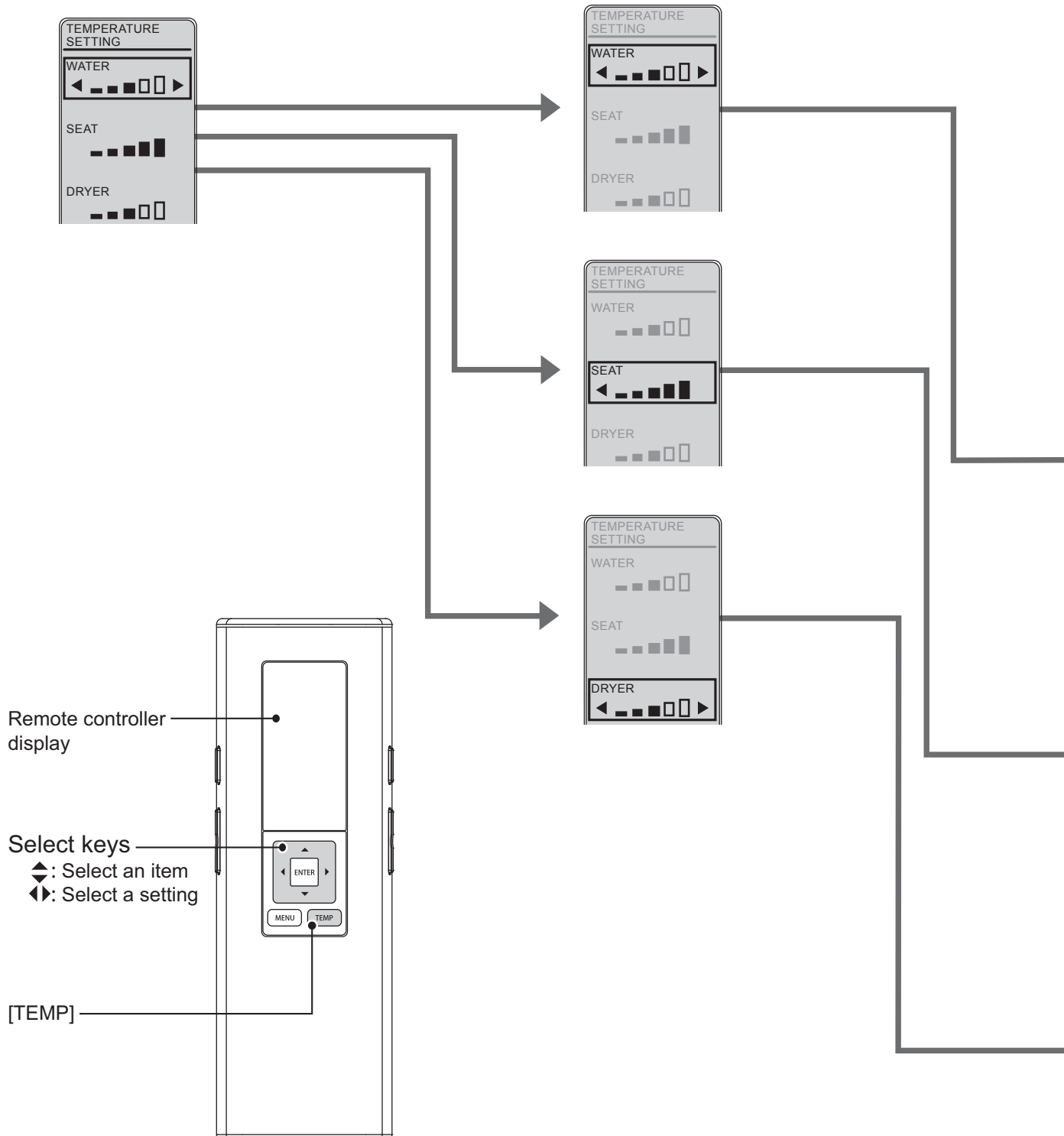



3



Use ◀▶ to select the temperature level.

<Settings complete>

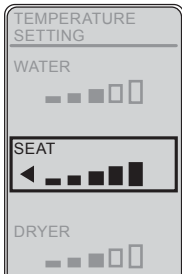

Warm water temperature

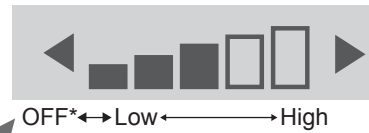

Press ◀ until "OFF" appears.

Toilet seat temperature

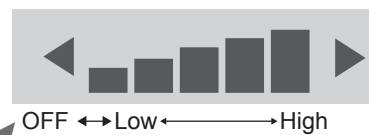

Press ◀ until "OFF" appears.

• When "OFF" is set, the SEAT LED will go off.

Drying air temperature

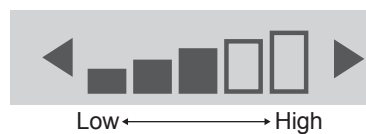



\*To prevent condensation, the water temperature does not drop below 20°C even when set to "OFF".

# Energy Saver Features Type



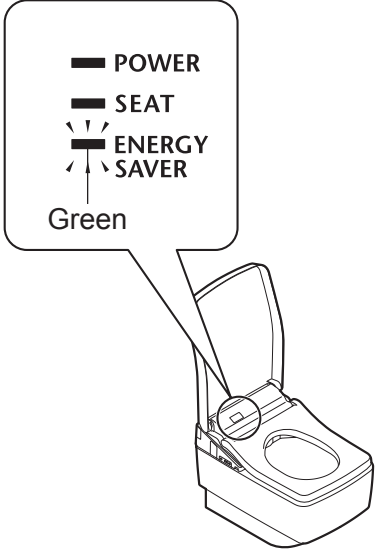

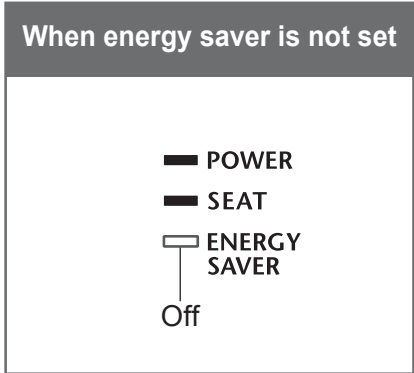
You can save energy by turning the toilet seat heater to a low temperature (or turning the heater "OFF") during periods when the toilet will be used infrequently.

- It takes about 10 days for the product to determine the periods when it is used relatively less frequently.

Type	Situation	When energy saver is set	
		Main Display	
<b>AUTO ENERGY SAVER</b>	<p><b>You want to save energy but dislike a cold toilet seat</b></p> <p>The Washlet detects time periods with infrequent use and lowers the toilet seat temperature automatically.</p>		→
<b>TIMER ENERGY SAVER</b>	<p><b>You want to save energy only for the preset duration of time.</b></p> <p>If you set the duration of time (3 hours, 6 hours or 9 hours) during which you want to save energy, the heater automatically turns off every day in the set time slot.</p>		→
<b>AUTO ENERGY SAVER + TIMER ENERGY SAVER</b>	<p><b>You want to save a lot of energy with auto energy saver and timer energy saver</b></p> <p>When both timer energy saver and auto energy saver are set, auto energy saver operates when timer energy saver is not operating.</p>		→

**Note**

- Even if the toilet seat heater is set to "Low" or "OFF", the toilet seat is temporarily heated when you sit on it.

When energy saver is in operation		AM		PM					
Toilet seat heater		0	6	8	5	9	0		
<p>Green</p> <p>POWER</p> <p>SEAT</p> <p>ENERGY SAVER</p> <p>Orange</p>	 <p>Low</p>	Example: Used infrequently from 9 pm to 6 am							
		Set temperature* <sup>1</sup>							
		Low temperature* <sup>2</sup>		Low temperature* <sup>2</sup>					
<p>POWER</p> <p>SEAT</p> <p>ENERGY SAVER</p> <p>Green</p>	 <p>OFF</p>	Example: Set from 8 am to 5 pm							
		Set temperature* <sup>1</sup>			Set temperature* <sup>1</sup>				
		OFF * <sup>3</sup>							
<ul style="list-style-type: none"> <li>• During timer energy-saver: Same LED indication as timer energy saver (See above)</li> <li>• During auto energy saver : Same LED indication as auto energy saver (See above)</li> </ul>	 <p>Low</p>  <p>OFF</p>	Example: When timer energy saver and auto energy saver are used together							
		Low temperature* <sup>2</sup>		Set temperature* <sup>1</sup>		Set temperature* <sup>1</sup>		Low temperature* <sup>2</sup>	
		OFF * <sup>3</sup>							

\*1 The toilet seat temperature set on Page 24.

\*2 The time period when the toilet seat heater is set to a low temperature by the auto energy saver.



\*3 The time period when the toilet seat heater is "OFF".

# Energy Saver Features

## How to Set

Set the timer energy saver at the time you want to start it.

**1**  Press [MENU].

**2**  Use  to select "ENERGY SAVER" and then press [ENTER].

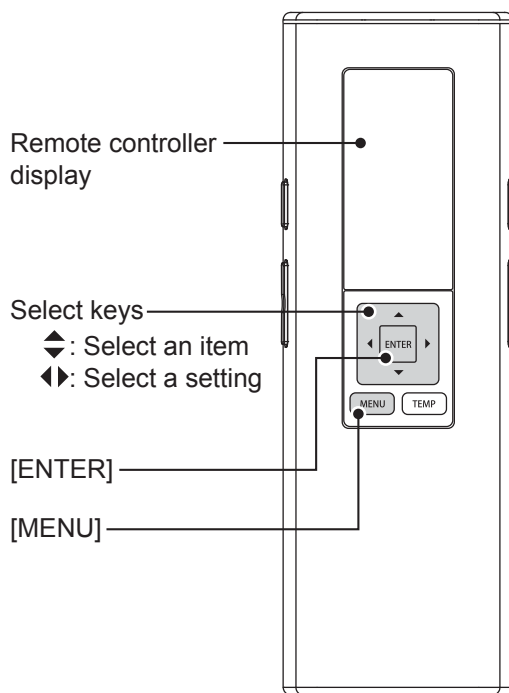
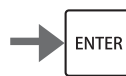
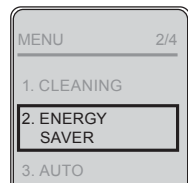

When energy saver is set, the ENERGY SAVER LED (green) lights up.

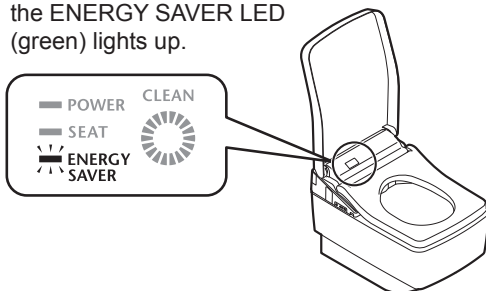

**AUTO ENERGY SAVER**

**TIMER ENERGY SAVER**

**TURNING OFF ENERGY SAVER**

3



Use **◆** to select "AUTO ENERGY SAVER".

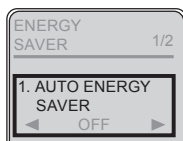

4



Use **◀▶** to select "ON/OFF" and then press [ENTER].

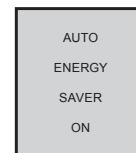
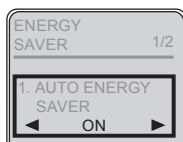

(To return → **MENU**)

3



Use **◆** to select "TIMER SAVER".



4



Use **◀▶** to select "3H", "6H", "9H" or "OFF" and then press [ENTER].

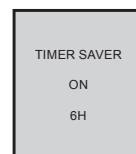

(To return → **MENU**)

■ To change the timer energy saver time → Set the timer energy saver again at the time you want to start it.

Select "OFF" in step 4 in each procedure above and then press [ENTER].

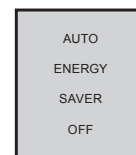
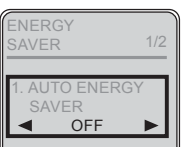

(To return → **MENU**)

# Maintenance

## Power plug (Perform monthly)

<Expect concealed power connection type>

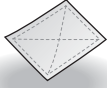

Dry cloth



Wet cloth

1

Disconnect the power plug and wipe it with a dry cloth.

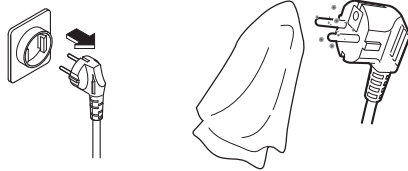

2

Insert the power plug.

## WARNING



● Periodically remove dust from the blades and other parts of the power plug.

- Disconnect the plug and wipe it with a dry cloth.

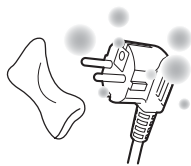

● Fully insert the power plug.

● When disconnecting, hold the main body of the power plug.

- Pulling the cord may damage the plug or cord.

## WARNING



Always disconnect the power plug from the outlet before cleaning, maintenance or inspection. (Page 15)

Always switch the breaker on the distribution board to OFF. (Concealed power connection type) (Otherwise, it may cause electrical shock or malfunction.)

**\*For safety, disconnect the power plug before cleaning or maintenance.**

**\*Switch the breaker on the distribution board to OFF.**  
(Concealed power connection type)

[Electrical box type]



Electrical box



Main unit

Power plug

Do not use a dry cloth or toilet paper on plastic parts.  
(May cause damage.)

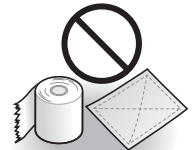

\*Except when using "Wand cleaning"

\*After the power plug is inserted (after the breaker on the distribution board is turned to "ON" (Concealed power connection type)), the toilet lid does not open automatically for about 10 to 60 seconds. Open and close by hands (because the unit is in warm-up operation).

## Main unit (Perform daily)



Soft cloth soaked in water

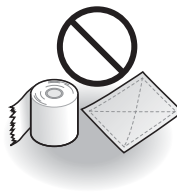

- Toilet paper
- Dry cloth
- Nylon scrubbing pads  
(May cause damage.)

**1** Unplug the power plug. (Page 15)  
Switch the breaker on the distribution board to OFF. (Concealed power connection type)

**2** Wipe with a soft cloth that has been soaked in water and wrung-out thoroughly.

■ For heavy dirt

- Wipe with a soft cloth soaked in diluted, neutral kitchen detergent, and then wipe with a soft cloth soaked in water.



• Neutral kitchen detergent



- Paint thinner
- Benzene
- Powdered cleanser

**3** Insert the power plug. (Page 15)  
Switch the breaker on the distribution board to ON. (Concealed power connection type)

Attention!

- **The Washlet is an electric appliance. Be careful not to let water seep inside or leave detergent in the gap between the main unit and toilet bowl.** (May damage plastic parts or cause a malfunction.)
- **When using a toilet cleaner to clean the toilet, wash it off within 3 minutes and leave the toilet seat and toilet lid open.**
  - Wipe off any cleaner that remains on the toilet bowl. (If vapor from a toilet bowl cleaner enters the main unit, it may cause a malfunction.)
- **Do not push or pull the wand cover or the warm air dryer cover with undue force.**  
(May cause damage or malfunction.)

# Maintenance

## Gap between the main unit and the toilet lid (Perform monthly)

The toilet lid can be removed for thorough cleaning.



Soft cloth soaked in water



Toilet paper, etc.  
(May cause damage.)

**1**

Unplug the power plug.  
(Page 15)

Switch the breaker on the distribution board to OFF.  
(Concealed power connection type)

**2**

Remove the toilet lid.

Ⓐ: Pull the left side outward.



Ⓑ: Disconnect the hinge from the pin and pull up.



Ⓒ: Disconnect the right side.

**3**

Wipe with a soft cloth that has been soaked in water and wrung-out thoroughly.

**4**

Reinstall the toilet lid.

Ⓓ: Join the pin and the hinge on the right side.



Ⓐ: While pulling out the left side,



Ⓔ: Mount by joining the hinge with the pin.  
\* Be careful not to pinch your fingers.

**5**

Insert the power plug. (Page 15)  
Switch the breaker on the distribution board to ON.  
(Concealed power connection type)

**6**

Open and close the toilet lid to check the reinstallation.

### Removing and Reinstalling

Hold with both hands

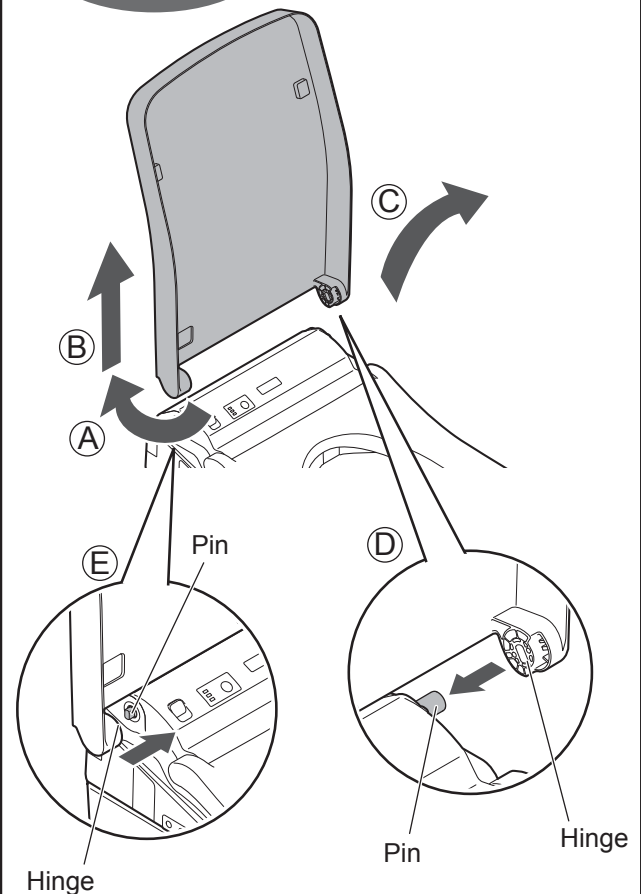



## Deodorizing filter (Perform monthly)

<If you notice odors>

1

Unplug the power plug.

(Page 15)

Switch the breaker on the distribution board to OFF.  
(Concealed power connection type)

2

Remove the deodorizing filter.

- Hold the knob and pull outward.
- Do not pull with undue force. (May cause damage or malfunctions)

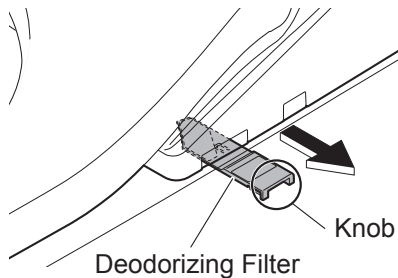

3

Clean with a tool such as a toothbrush.

- When washing with water, dry off all water before mounting.

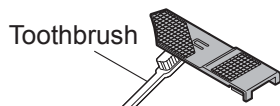

4

Mount the deodorizing filter.

- Push firmly until a click sound is heard.

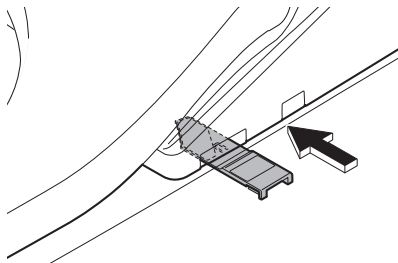

5

Insert the power plug.

(Page 15)

Switch the breaker on the distribution board to ON.  
(Concealed power connection type)



Deodorizing Filter

# Maintenance

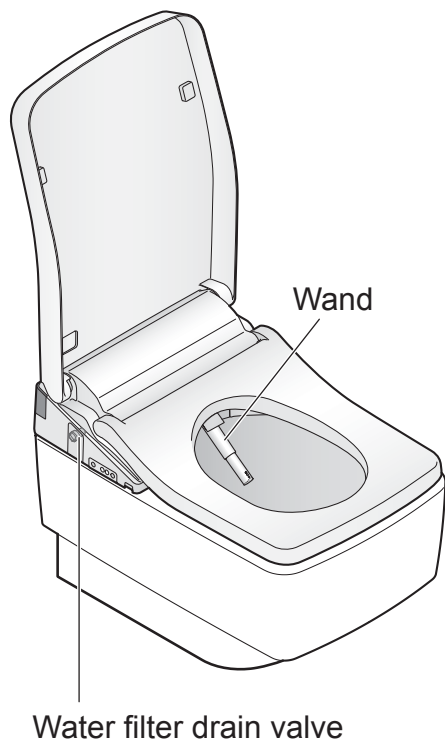

## Wand (Perform monthly) <Wand cleaning> If you notice dirt



Soft cloth soaked in water



Toilet paper, etc.  
(May cause damage.)

1

### Extend the wand.

- Operate with the buttons on the back side of the remote control.

(1) Press [MENU].

(2) Use  to select "CLEANING".

Press [ENTER].

(3) Use  to select "WAND CLEANING MODE ON/OFF".

Press [ENTER].

- The wand extends and water sprays out for cleaning.
- The wand automatically retracts after about 5 minutes.

2

### Wipe with a soft, wet cloth.

- Do not pull, push or press the wand with excessive force.  
(May cause damage or malfunction.)

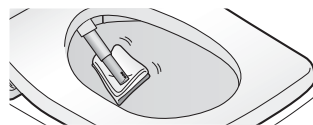

3

### Press [STOP] on the front side of the remote control.

- The wand retracts.

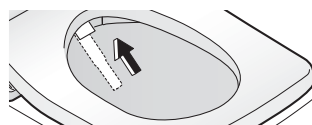

# Water filter drain valve (Perform once every 6 months)

<If you think the water pressure has weakened>

- 1** Close the shutoff valve.
- The water supply stops.

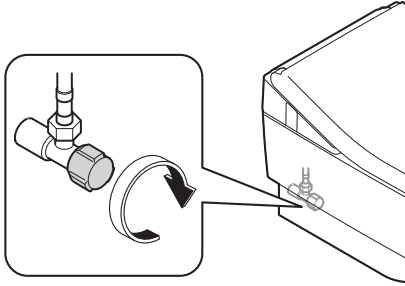



## **CAUTION**



Do not remove the water filter drain valve while the shutoff valve is open. (Otherwise, water may leak out)

- 2** Extend the wand.
- Operate with the buttons on the back side of the remote control.

- (1) Press [MENU].
- (2) Use  to select "CLEANING". Press [ENTER].
- (3) Use  to select "WAND CLEANING MODE ON/OFF". Press [ENTER] to extend the wand.  
Press [ENTER] again to retract the wand.  
(Release the pressure from the water supply pipe.)

- 3** Unplug the power plug. (Page 15)
- Switch the breaker on the distribution board to OFF. (Concealed power connection type)

- 4** Remove the cover and water filter drain valve.
- Loosen with a flat-head screwdriver and then pull.

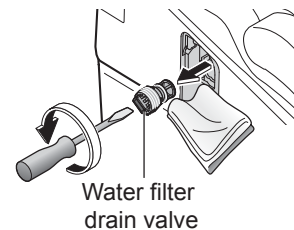
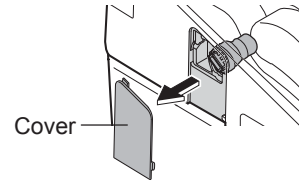

- 5** Clean with a tool such as a toothbrush.
- Also, remove any dust from inside the hole of the water filter drain valve.

- 6** Reinstall the water filter drain valve and cover.
- Insert the water filter drain valve and tighten it securely with a flat-head screwdriver.

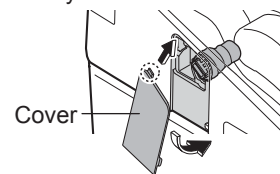

- 7** Insert the power plug. (Page 15)
- Switch the breaker on the distribution board to ON. (Concealed power connection type)

- 8** Open the shutoff valve. (Page 15)

# Changing Settings

## Setting List

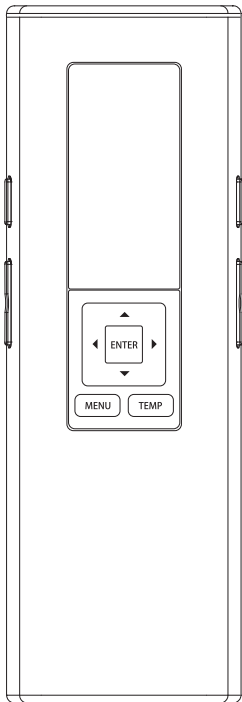

		Setting Types
AUTO FUNCTIONS	AUTO OPEN/CLOSE	AUTO OPEN/CLOSE
		AUTO CLOSE WAITING TIME
		AUTO OPEN WAITING TIME
		SEAT/LID
	CLEANING	AUTO WAND CLEANING
		AUTO BOWL CLEANING
		DEODORIZER
	LIGHT	SOFT LIGHT
		BOWL LIGHT
INDICATOR		
OTHER SETTINGS	BEEP	
	SETTING LOCK	
	PERSONAL SETTING LOCK	



	Available Settings*	Setting Ref. Page
<ul style="list-style-type: none"> <li>• Set whether or not to open the toilet lid automatically</li> </ul>	<b>ON/OFF</b>	<b>Page 38</b>
<ul style="list-style-type: none"> <li>• Change the amount of time before the lid/seat closes automatically</li> </ul>	<b>25SEC/90SEC</b>	
<ul style="list-style-type: none"> <li>• Change the amount of time after which the lid/seat opens automatically upon closing it with hands</li> </ul>	<b>15SEC/30SEC/90SEC</b>	<b>Page 40</b>
<ul style="list-style-type: none"> <li>• Automatically open and close the toilet lid/ Automatically open and close the toilet seat and toilet lid</li> </ul>	<b>LID/SEAT · LID</b>	
<ul style="list-style-type: none"> <li>• Set whether or not to clean the wand automatically</li> </ul>	<b>ON/OFF</b>	<b>Page 42</b>
<ul style="list-style-type: none"> <li>• Set whether or not to spray mist in the toilet bowl automatically.</li> </ul>	<b>ON/OFF</b>	
<ul style="list-style-type: none"> <li>• Set whether or not to deodorize automatically after sitting on the toilet seat</li> </ul>	<b>ON/OFF</b>	
<ul style="list-style-type: none"> <li>• Set whether or not to use the soft light</li> </ul>	<b>ON/OFF</b>	<b>Page 44</b>
<ul style="list-style-type: none"> <li>• Set whether or not to use the light inside the toilet bowl</li> </ul>	<b>ON/OFF</b>	
<ul style="list-style-type: none"> <li>• Set whether or not to light up the CLEAN indicator</li> </ul>	<b>ON/OFF</b>	
<ul style="list-style-type: none"> <li>• Set whether or not to make a beep sound</li> </ul>	<b>ON/OFF</b>	<b>Page 46</b>
<ul style="list-style-type: none"> <li>• Set whether or not to use the setting lock</li> </ul>	<b>ON/OFF</b>	
<ul style="list-style-type: none"> <li>• Set whether or not to use the personal setting lock</li> </ul>	<b>ON/OFF</b>	

\*The black text is the initial setting.



# Changing Settings

## AUTO OPEN/CLOSE

**1**  Press [MENU].

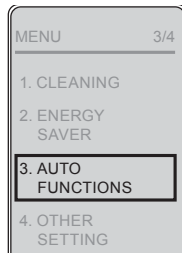
**2**  Use  to select "AUTO FUNCTIONS" and then press [ENTER].



**3**  Use  to select "1. AUTO OPEN/CLOSE" and then press [ENTER].

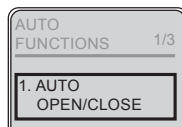

Set whether or not to open the toilet lid automatically

**AUTO OPEN/  
CLOSE**

Change the time before the lid/seat closes automatically (25 SEC or 90 SEC)<sup>\*2</sup>

**AUTO CLOSE  
WAITING  
TIME<sup>\*1</sup>**

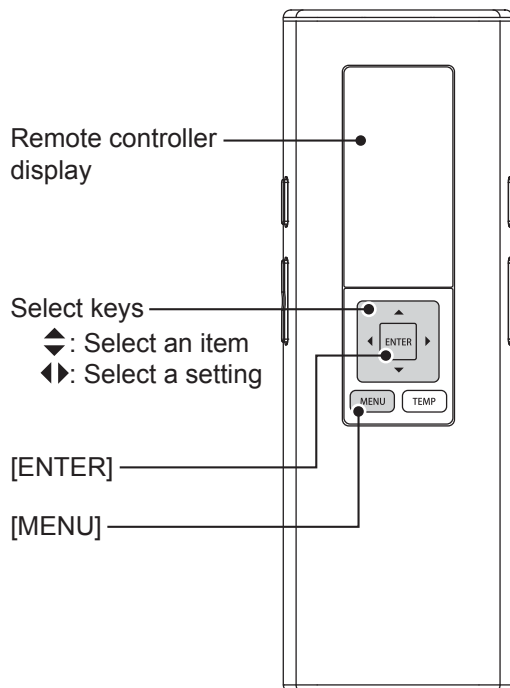

### Items set on this display

1. AUTO OPEN/CLOSE
2. AUTO CLOSE WAITING TIME

4



Use  $\blacktriangle$  to select "AUTO OPEN/CLOSE".

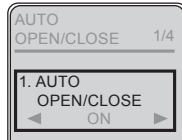

5



Use  $\blacktriangle$  to select "ON/OFF" and then press [ENTER].

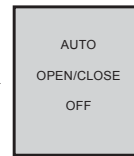
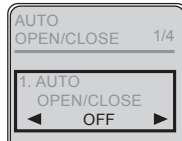

(To return → MENU)

4



Use  $\blacktriangle$  to select "AUTO CLOSE WAITING TIME".

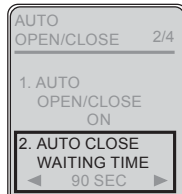

5



Use  $\blacktriangle$  to select "25SEC" or "90SEC" and then press [ENTER].

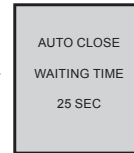
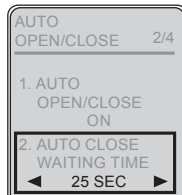

(To return → MENU)



\*1 "AUTO OPEN/CLOSE" is not available on any setting whenever "AUTO OPEN/CLOSE" is "OFF."

\*2 When set to 25 seconds, the lid/seat does not open automatically for about 15 seconds after closing automatically.



# Changing Settings

## AUTO OPEN/CLOSE

**1**  Press [MENU].

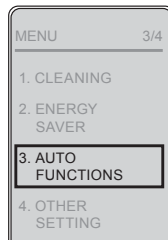
**2**  Use  to select "AUTO FUNCTIONS" and then press [ENTER].



**3**  Use  to select "AUTO OPEN/CLOSE" and then press [ENTER].

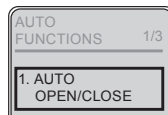

Change the time period till automatic opening (15 SEC, 30 SEC or 90 SEC) (After closing manually.)

**AUTO OPEN WAITING TIME\*1**

Automatically open and close the toilet lid only/ Automatically open and close the toilet seat and toilet lid\*2

**SEAT/LID\*1**

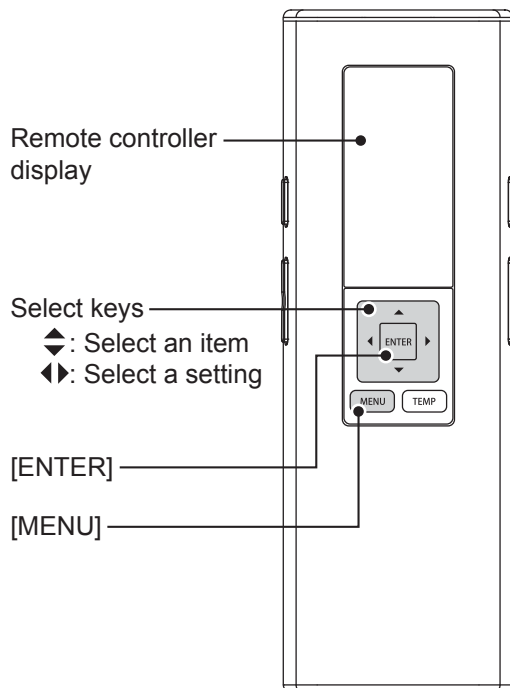

### Items set on this display

- 3. AUTO OPEN WAITING TIME
- 4. SEAT/LID



4



Use to select "AUTO OPEN WAITING TIME".

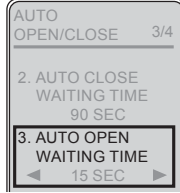

5



Use to select "15SEC", "30SEC" or "90SEC" and then press [ENTER].

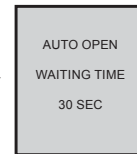
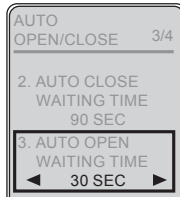

(To return → )

4



Use to select "SEAT/LID".

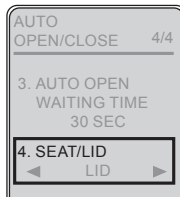

5



Use to select "LID" or "SEAT · LID" and then press [ENTER].

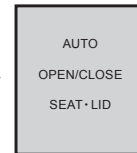
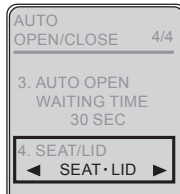

(To return → )



\*1 "AUTO OPEN/CLOSE" is not available on any setting whenever "AUTO OPEN/CLOSE" is "OFF."



\*2 When the toilet seat and toilet lid are set to open automatically, pre-mist is not sprayed.

# Changing Settings

## CLEANING

**1**  Press [MENU].

**2**  Use  to select "AUTO FUNCTIONS" and then press [ENTER].

**3**  Use  to select "CLEANING" and then press [ENTER].

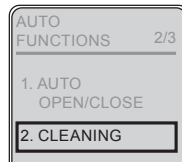
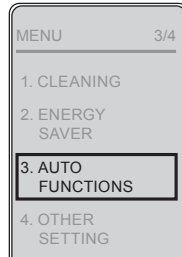

Set whether or not to clean the wand automatically  
**AUTO WAND CLEANING**

Set whether or not to spray mist in the toilet bowl automatically  
**AUTO BOWL CLEANING**

Set whether or not to deodorize automatically after sitting on the toilet seat  
**DEODORIZER**

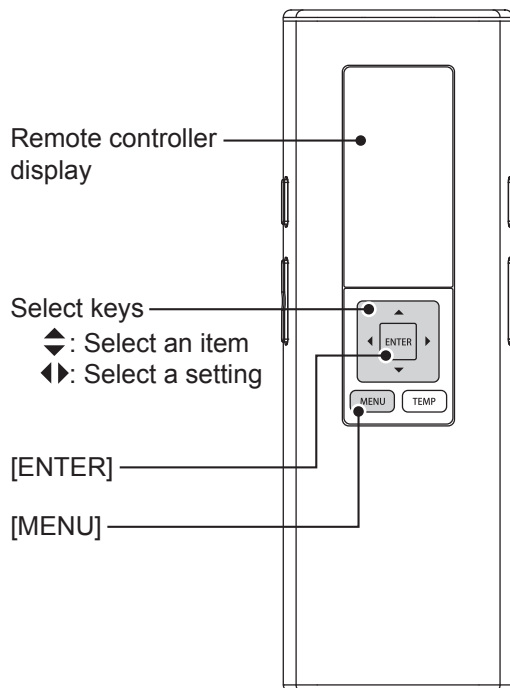

### Items set on this display

1. AUTO WAND CLEANING
2. AUTO BOWL CLEANING
3. DEODORIZER

4



Use to select "AUTO WAND CLEANING".



5



Use to select "ON/OFF" and then press [ENTER].

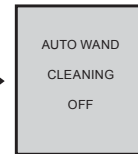
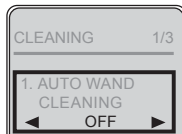

(To return → )

4



Use to select "AUTO BOWL CLEANING".

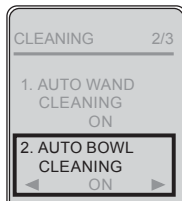

5



Use to select "ON/OFF" and then press [ENTER].

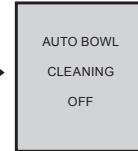
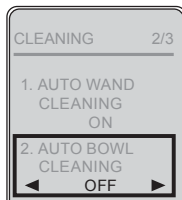

(To return → )

4



Use to select "DEODORIZER".

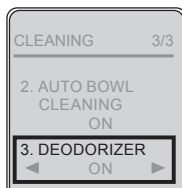

5



Use to select "ON/OFF" and then press [ENTER].

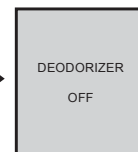
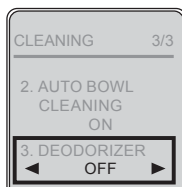



(To return → )

# Changing Settings

## LIGHT

**1**  Press [MENU].

**2**  Use  to select "AUTO FUNCTIONS" and then press [ENTER].

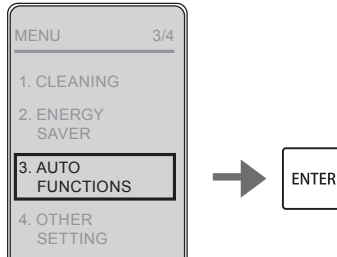

**3**  Use  to select "LIGHT" and then press [ENTER].

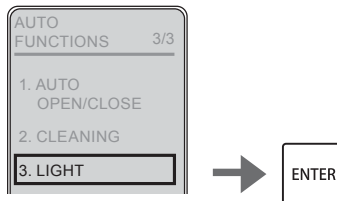

Set whether or not to use the soft light  
**SOFT LIGHT**

Set whether or not to use the light inside the toilet bowl  
**BOWL LIGHT**

Set whether or not to light up the CLEAN indicator  
**INDICATOR**

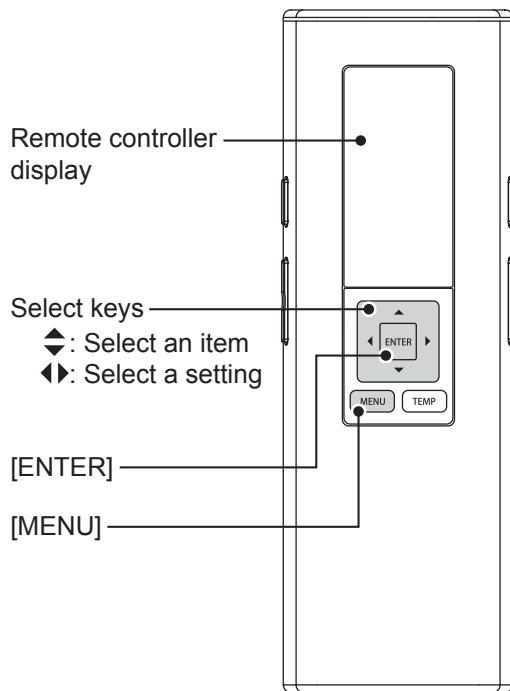

### Items set on this display

1. SOFT LIGHT
2. BOWL LIGHT
3. INDICATOR

4



Use  $\blacktriangleup$  to select "SOFT LIGHT".



5



Use  $\blacktriangleright$  to select "ON/OFF" and then press [ENTER].

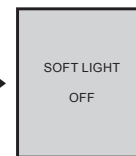

(To return → MENU)

4



Use  $\blacktriangleup$  to select "BOWL LIGHT".



5



Use  $\blacktriangleright$  to select "ON/OFF" and then press [ENTER].

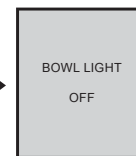

(To return → MENU)

4



Use  $\blacktriangleup$  to select "INDICATOR".

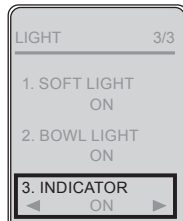

5



Use  $\blacktriangleright$  to select "ON/OFF" and then press [ENTER].

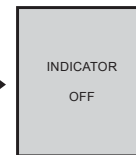
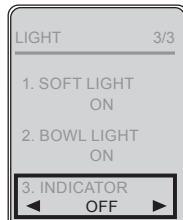

(To return → MENU)

# Changing Settings

## OTHER SETTINGS

1



Press [MENU].

2



Use  to select "OTHER SETTINGS" and then press [ENTER].

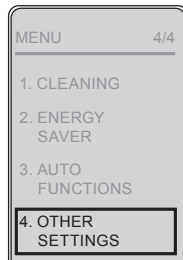

Set whether or not to make a beep sound

**BEEP**

Set whether or not to use the setting lock

**SETTING LOCK**

Set whether or not to use the personal setting lock

**PERSONAL SETTING LOCK**

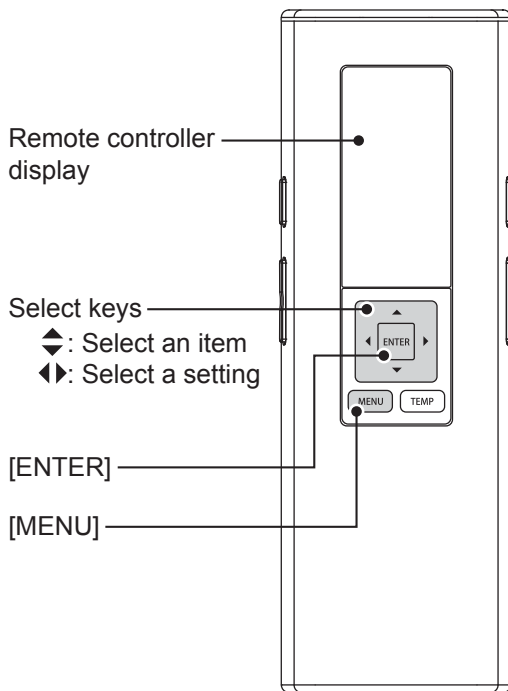

### Items set on this display

1. BEEP
2. SETTING LOCK
3. PERSONAL SETTING LOCK

3



Use  $\blacktriangle\blacktriangledown$  to select "BEEP".

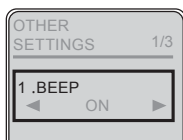

4



Use  $\blacktriangleleft\blacktriangleright$  to select "ON/OFF" and then press [ENTER].

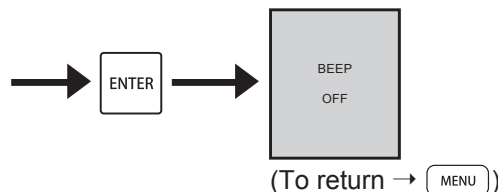
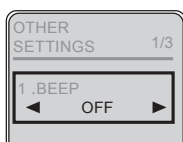

3



Use  $\blacktriangle\blacktriangledown$  to select "SETTING LOCK".



4



Use  $\blacktriangleleft\blacktriangleright$  to select "ON/OFF" and then press [ENTER].

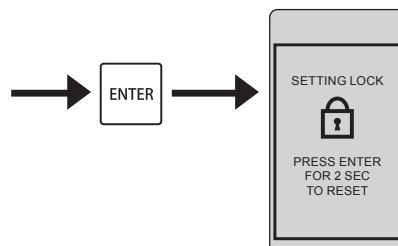

5

Check the displayed screen.



Display screen during setting lock

Cancellation method:  
Press [ENTER] for 2 seconds or longer.

\*If you want to relock after cancellation, reconfigure the setting.

3



Use  $\blacktriangle\blacktriangledown$  to select "PERSONAL SETTING LOCK".

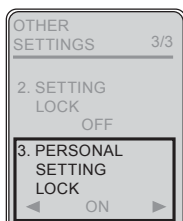

4



Use  $\blacktriangleleft\blacktriangleright$  to select "ON/OFF" and then press [ENTER].

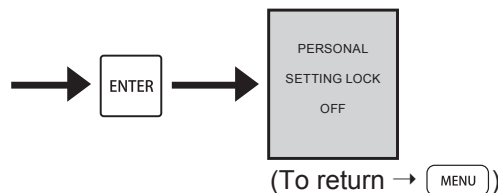
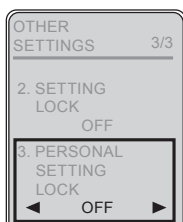

# What to Do?

## If you cannot operate with the remote control

- Operation is also possible using the buttons on the control panel.
- The batteries may have worn out. Replace the batteries.

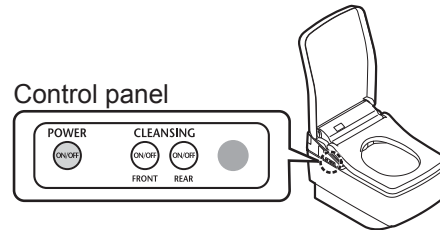

### ■ Replacing the batteries

- 1** Press [POWER ON/OFF] on the control panel.
  - The POWER LED goes off.
- 2** Remove the remote control from the hanger.  
(Page 14)
- 3** Open the cover and replace the AA batteries.  
(Page 14)
- 4** Mount the remote control in the hanger.
- 5** Press [POWER ON/OFF] on the control panel.
  - The POWER LED lights up.

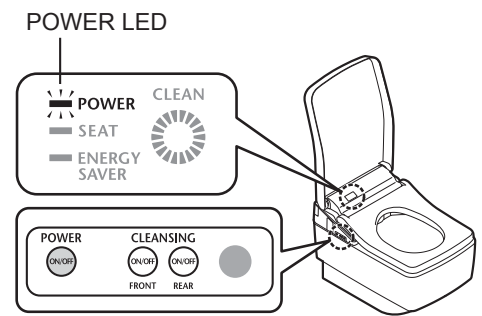



# What to Do?

## Freeze Damage Prevention

When the ambient temperature is likely to drop to 0°C or lower, take measures to prevent freezing.

### Attention!

- When the ambient temperature is likely to drop to 0°C or lower, do not use the energy saver feature. (May damage the product.)
- Warm the bathroom or take measures against freeze so that the ambient temperature does not drop below 0°C.
- Before starting work, set "AUTO OPEN/CLOSE" (Page 38) to "OFF".



## Anti freezing

### ■ How to drain the water

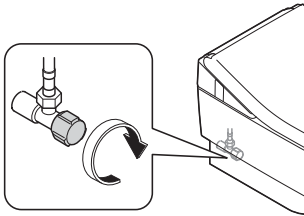
#### 1 Close the shutoff valve.



#### 2 Drain the pipe.

- (1) Extend the wand.
  - Operate with the buttons on the back side of the remote control.
    1. Press [MENU].
    2. Use  to select "CLEANING". Press [ENTER].
    3. Use  to select "WAND CLEANING MODE ON/OFF". Press [ENTER] to extend the wand.
      - Hold the wand in the extended position until no more water comes from around the wand.

Press [ENTER] again to retract the wand. (Release the pressure from the water supply pipe.)

- (2) Unplug the power plug. (Page 15)  
Switch the breaker on the distribution board to OFF. (Concealed power connection type)
- (3) Remove the cover and water filter drain valve.

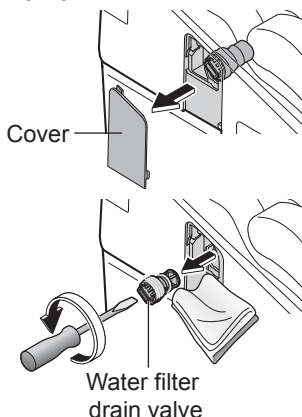

- (4) After draining the water, install the water filter drain valve and cover.
  - Insert the water filter drain valve and use a flat-head screwdriver to tighten it securely.

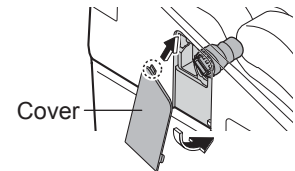

- (5) Insert the power plug. (Page 15)  
Switch the breaker on the distribution board to ON. (Concealed power connection type)

#### 3 Check that the POWER LED on the main display is lit up. (Page 15)

- #### 4 Set the toilet seat temperature to "High". (Page 24)
- (To maintain the temperature.)
- When finished, close the toilet seat and toilet lid.

### ■ To use the Washlet again

- The water needs to be resupplied. (Page 50)

# What to Do?

## Long Periods of Disuse

If the toilet is in a location you will not visit for a long time, drain the water.  
(The water in the tank may become contaminated and cause skin irritation or other problems.)

### How to drain the water

- 1 Close the shutoff valve. (Page 51)
- 2 Drain the pipe.  
(Step 2 (1) to (4) on Page 49)
- 3 Pull out the water drain lever.
  - The water comes out from near the wand for about 20 seconds.
- 4 Release your hand to return the water drain lever to its original position.

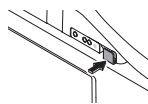
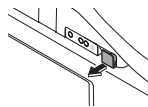

#### ■ If water may get frozen

- Add antifreeze solution in the water in the bowl to prevent freezing.  
(The antifreeze solution should not be flushed out. Collect it before using the toilet and dispose of it.)

#### ■ To use the Washlet again

- The water needs to be resupplied. (See right)

### Resupplying the Water (After draining)

- 1 Open the shutoff valve.  
Check that water is not leaking from a pipe or the main unit.
  - 2 If the power is not turned ON  
Insert the power plug. (Page 15)  
Switch the breaker on the distribution board to ON.  
(Concealed power connection type)
  - 3 Discharge water from the wand.
    - (1) Pressing down the left side of the toilet seat,
    - (2) Press the "REAR" on the remote control to discharge water from the wand.  
(Catch the water in a paper cup or other receptacle)
- If the remaining water has frozen and no water comes out
- Heat the inside of the bathroom, and warm the water supply hose and shutoff valve using a cloth soaked in warm water.

# Troubleshooting

First, try the actions described on pages 51 to 56. If the problem persists, consult the installer, seller or the contact listed on the back cover of this manual.

- The **CLEAN** indicator does not light up  
(It is time for parts replacement. → Page 56)

**CAUTION**

 **If a water leak occurs, close the shutoff valve.**

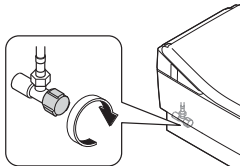

## Please check first

Is the **POWER LED** lit?

- Does the LED light up when you press [POWER ON/OFF] on the main unit?
- Is the breaker on the distribution board turned on?  
→ Check whether there is a power outage or the breaker has turned "OFF".

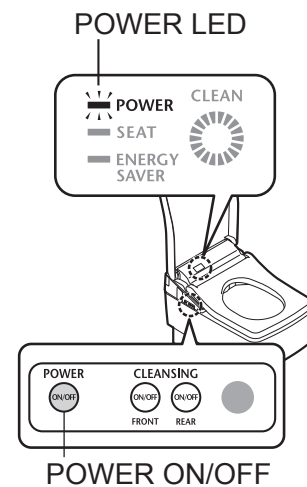

Is the **ENERGY SAVER LED** lit?

- While the LED is lit, energy saver (Page 26) is in operation, so the toilet seat temperature may be reduced or the heater may be turned off.

Is the **remote control working?**

- Are the remote control batteries dead?  
→ Replace the batteries. (Page 48)
- Is the remote control transmitter or the remote control receiver blocked?  
→ Remove obstructions, dirt, water droplets or any other blockages.

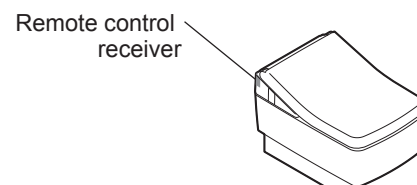
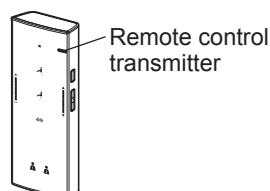
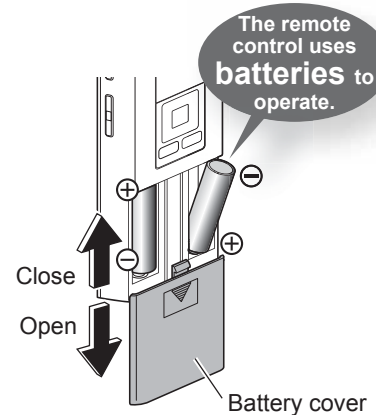

# Troubleshooting

## Rear and Front Cleansing, Wand

Trouble	Please check	Ref. Page
<p><b>The wand (or cleansing water) does not come out</b></p>	<ul style="list-style-type: none"> <li>● Can you operate with the control panel? (Check while sitting on the toilet seat.) → Check "Is the remote control working?"</li> </ul>	<p><b>12</b> <b>51</b></p>
	<ul style="list-style-type: none"> <li>● When the temperature is low, it takes time for the wand to come out after the remote control button is pressed because the water must be warmed up first.</li> </ul>	<p>-</p>
	<ul style="list-style-type: none"> <li>● Did you sit on the toilet continuously for 2 hours or longer? (If so, operation is stopped for safety purposes.) → Stand up from the seat and then use again.</li> </ul>	<p>-</p>
	<ul style="list-style-type: none"> <li>● If the water supply pressure drops significantly, for example if water is used elsewhere or if there is a water failure, the function may stop for safety. → Disconnect the power plug and wait about 10 seconds before inserting it again. → Switch the breaker on the distribution board to OFF and wait about 10 seconds before inserting it again. (Concealed power connection type) If the same symptom reappears → There may be a malfunction. Consult with the contact listed on the back cover of this manual.</li> </ul>	<p>-</p>
	<ul style="list-style-type: none"> <li>● The seat switch may have difficulty detecting some sitting postures. → Sit back on the toilet seat.</li> </ul>	<p><b>11</b></p>
	<ul style="list-style-type: none"> <li>● Are you using a toilet seat cover, a toilet lid cover or a seat for infants? → Remove any covers. When using a seat for infants or a soft highchair, remove after each use.</li> </ul>	 <p><b>11</b></p>
<p><b>The wand extends but the cleansing water does not come out /The cleansing water pressure is weak</b></p>	<ul style="list-style-type: none"> <li>● Has a water failure occurred? → Press the "STOP" button and wait until water service is restored.</li> </ul>	<p>-</p>
	<ul style="list-style-type: none"> <li>● Is the shutoff valve closed?</li> </ul>	<p><b>15</b></p>
	<ul style="list-style-type: none"> <li>● Is the water filter drain valve clogged with foreign matter? → Clean the filter.</li> </ul>	<p><b>35</b></p>
	<ul style="list-style-type: none"> <li>● Is the water pressure set to a low level?</li> </ul>	<p><b>16</b></p>
<p><b>The cleansing water is cold</b></p>	<ul style="list-style-type: none"> <li>● Is the water temperature set to "OFF" or a low level?</li> <li>● When the temperature of the water supply or the bathroom is low, the water temperature may be low when first sprayed.</li> </ul>	<p><b>24</b> -</p>
<p><b>Stops in the middle of use</b></p>	<ul style="list-style-type: none"> <li>● Rear, rear soft and front cleansing stop automatically after 5 minutes of continuous use. After that, the POWER LED (green) and the ENERGY SAVER LED (green) on the display of the main unit flicker for about 60 sec. in order to prepare hot water. → Wait until the LEDs on the display of the main unit light up solidly and then press the button again.</li> </ul>	<p>-</p>
	<ul style="list-style-type: none"> <li>● Does the seat switch have difficulty detecting? → Sit back on the toilet seat. If you get up slightly from the seat, or sit forward on the seat, the seating switch may temporarily stop detecting your presence.</li> </ul>	<p><b>11</b></p>
<p><b>Water comes out unexpectedly from the wand</b></p>	<ul style="list-style-type: none"> <li>● Water comes out from the area around the wand for several seconds after you sit and stand up from the toilet seat.</li> <li>● Has the CLEAN indicator lit up in a cycle? <ul style="list-style-type: none"> <li>• The wand is cleaned with "ewater+".</li> </ul> </li> </ul>	<p><b>20</b></p>

## Warm Air Drying

Trouble	Please check	Ref. Page
<b>The dryer temperature is low</b>	<ul style="list-style-type: none"> <li>● Is the remote control preset temperature set to a low level?</li> </ul>	<b>24</b>
<b>Stops in the middle of use</b>	<ul style="list-style-type: none"> <li>● The feature stops automatically after 10 minutes of continuous use.</li> <li>● Does the seat switch have difficulty detecting?                             <ul style="list-style-type: none"> <li>→ Sit back on the toilet seat. If you get up slightly from the seat, or sit forward on the seat, the seating switch may temporarily stop detecting your presence.</li> </ul> </li> </ul>	- <b>11</b>

## Toilet Seat and Toilet Lid (AUTO OPEN/CLOSE)

<b>The toilet lid does not open automatically</b>	<ul style="list-style-type: none"> <li>● Is "AUTO OPEN/CLOSE (LID)" set to "OFF"? → Set to "ON".</li> </ul>	<b>38</b>
	<ul style="list-style-type: none"> <li>● Does the body sensor have difficulty detecting?                             <ul style="list-style-type: none"> <li>→ Remove any dirt that is on the body sensor.</li> </ul> </li> </ul>	<b>11</b>
	<ul style="list-style-type: none"> <li>● Even when set to "ON", AUTO OPEN/CLOSE (LID) is not performed for about 15 seconds after the toilet seat or toilet lid is closed.                             <ul style="list-style-type: none"> <li>• When the toilet lid is closed by hand (To make the Washlet more user-friendly, a time interval is set from when the lid is closed to when it will open next.)</li> <li>→ Leave the bathroom, and then after 15 seconds or more, approach the toilet bowl.</li> </ul> </li> </ul>	<b>22</b>
	<ul style="list-style-type: none"> <li>● Detection by the body sensor may be difficult when the room temperature exceeds 30°C.                             <ul style="list-style-type: none"> <li>→ Open and close manually.</li> </ul> </li> </ul>	<b>11</b>
	<ul style="list-style-type: none"> <li>● Is "AUTO OPEN WAITING TIME" set to 30s or 90s?</li> </ul>	<b>40</b>
<b>The toilet lid does not close automatically</b>	<ul style="list-style-type: none"> <li>● After the power plug is inserted, the toilet lid does not open automatically for about 10 to 60 seconds.                             <ul style="list-style-type: none"> <li>→ Open and close by hand.</li> </ul> </li> <li>● After switching the breaker on the distribution board to ON, the toilet lid does not open automatically for about 10 to 60 seconds.                             <ul style="list-style-type: none"> <li>→ Open and close by hand. (Concealed power connection type)</li> </ul> </li> </ul>	-
	<ul style="list-style-type: none"> <li>● Is a toilet seat or lid cover installed?                             <ul style="list-style-type: none"> <li>→ Remove any covers.</li> </ul> </li> </ul>	<b>11</b>
	<ul style="list-style-type: none"> <li>● Is "AUTO OPEN/CLOSE (LID)" set to "OFF"?                             <ul style="list-style-type: none"> <li>→ Set to "ON".</li> </ul> </li> <li>● When you do not sit on the toilet seat, or when the time spent sitting on the toilet seat or standing in front of it is 6 seconds or less, the toilet seat and toilet lid close after about 5 minutes.</li> <li>● If they do not close automatically even though "AUTO OPEN/CLOSE (LID)" is set to "ON", the body sensor may be detecting incorrectly.                             <ul style="list-style-type: none"> <li>→ If there is a reflective object in front, such as a mirror or glass, move the reflective object or use a curtain or other object to block it.</li> </ul> </li> </ul>	<b>38</b> <b>22</b> <b>11</b>

# Troubleshooting

## Toilet Seat and Toilet Lid (AUTO OPEN/CLOSE) (Continued)

Trouble	Please check	Ref. Page
<p><b>The toilet lid opens on its own</b></p>	<ul style="list-style-type: none"> <li>● Is the sensor directly exposed to sunlight? → Do not directly expose the sensor to sunlight, because it may cause incorrect detection.</li> <li>● Is there a heater within the detection range of the body sensor? → Do not place within the detection range of the sensor.</li> <li>● Is a urinal or wash basin also installed in the bathroom? → The sensor may detect someone using the urinal, causing the toilet lid to open or close.</li> </ul>	11
<p><b>The toilet lid closes on its own</b></p>	<ul style="list-style-type: none"> <li>● Is "AUTO OPEN/CLOSE (LID)" set to "ON"?</li> <li>● Is AUTO CLOSE WAITING TIME set to 25s?</li> <li>● The seat switch may have difficulty detecting some sitting postures. → Sit back on the toilet seat.</li> </ul>	38 11
<p><b>The toilet lid and toilet seat open at the same time</b></p>	<ul style="list-style-type: none"> <li>● Are the settings configured to open the toilet lid and toilet seat at the same time?</li> </ul>	40
<p><b>Stops (or closes) while opening</b></p>	<ul style="list-style-type: none"> <li>● If the lid or seat hits an obstruction the first time it opens after inserting the power plug, it may stop (or close) partway during the next operation. → While there are no obstructions, disconnect the plug and insert it again after about 5 seconds. Then press the "OPEN/CLOSE (Seat)" button on the remote control.</li> <li>● If the lid or seat hits an obstruction the first time it opens after switching ON the breaker on the distribution board, it may stop (or close) partway during the next operation. → Eliminate any obstructions and switch the breaker on the distribution board to OFF. Switch it to ON again after about 5 seconds. Then press the "OPEN/CLOSE (Seat)" button on the remote control. (Concealed power connection type)</li> </ul>	-
<p><b>The open timing has changed</b></p>	<ul style="list-style-type: none"> <li>● Detection by the body sensor may be difficult when the room temperature exceeds 30°C, such as in the summertime.</li> </ul>	11
<p><b>Cannot open or close with the remote control</b></p>	<ul style="list-style-type: none"> <li>● If it opens automatically → Check "Is the remote control working?"</li> <li>● If automatic opening does not work either               <ul style="list-style-type: none"> <li>• The toilet lid may not be mounted correctly. → Mount them correctly.</li> </ul> </li> <li>● Incorrect detection may occur when operating under fluorescent lights.</li> </ul>	51 32 -

## Toilet Seat and Toilet Lid

Trouble	Please check	Ref. Page
<b>The toilet seat does not get warm</b>	<ul style="list-style-type: none"> <li>● Is the toilet seat temperature set to "OFF" or a low level?</li> </ul>	24
	<ul style="list-style-type: none"> <li>● Is the ENERGY SAVER LED(green) lit and is the SEAT LED off?                             <ul style="list-style-type: none"> <li>• Timer energy saver is operating and has turned off the toilet seat heater.</li> <li>→ When you sit on the seat, the heater is turned on temporarily and the seat is warmed in about 15 minutes.</li> </ul> </li> <li>● Is the ENERGY SAVER LED (orange) lit?                             <ul style="list-style-type: none"> <li>• The toilet seat temperature has been lowered to save energy (The auto energy saver in operation).</li> <li>→ When you sit on the seat, the heater is turned on temporarily and the seat is warmed in about 15 minutes.</li> </ul> </li> </ul>	26
	<ul style="list-style-type: none"> <li>● Have you been seated for a long time?                             <ul style="list-style-type: none"> <li>• After about 20 minutes of sitting, the temperature starts going down, and after about 1 hour, the heater is turned "OFF".</li> <li>→ Move away from the toilet seat and then go back.</li> </ul> </li> </ul>	-
	<ul style="list-style-type: none"> <li>● The seat switch may have difficulty detecting some sitting postures.</li> <li>→ Sit back on the toilet seat.</li> </ul>	11
	<ul style="list-style-type: none"> <li>● Is a toilet lid or seat cover installed?</li> <li>→ Remove any covers.</li> </ul>	11

## Energy Saver

Trouble	Please check	Ref. Page
<b>The timer energy-saver feature is not working</b>	<ul style="list-style-type: none"> <li>● Did you replace the remote control batteries?                             <ul style="list-style-type: none"> <li>• When the batteries are discharged, the settings may be erased.</li> <li>→ Reconfigure the setting.</li> </ul> </li> </ul>	14 28
<b>The auto energy-saver feature is not working</b>	<ul style="list-style-type: none"> <li>● Because the function takes several days learning the usage conditions before starting energy saver, the amount of energy saving may be low, depending on the frequency of use.</li> <li>→ Check the type of energy saver.</li> </ul>	26

# Troubleshooting

## Deodorizer

Trouble	Please check	Ref. Page
The deodorizer seems to be not working	● Even after sitting down, you do not hear operation sounds. → Sit back on the toilet seat.	11
	● If you hear an operation sound when you sit on the toilet seat. → Clean the deodorizing filter.	33
A strange odor is emitted	● Are you using an air freshener or deodorizer that you purchased separately? • Doing so may reduce the effectiveness of the Washlet deodorizer or cause strange odors. → Remove the air freshener or deodorizer.	-
The deodorizer is not working	● Is "DEODORIZER" set to "OFF"? → Set to "ON".	42

## Sanitary

Trouble	Please check	Ref. Page
The soft light or bowl light does not light up	● Is the setting "OFF"? → Set to "ON".	44
The mist sprays out spontaneously	● When body sensor A detects someone, the pre-mist is sprayed.	11
	● When the cleansing functions have not been used in 8 hours, mist is sprayed inside the toilet bowl automatically.	20
The CLEAN indicator does not light up	● Is the setting "OFF"? → Set to "ON".	44
	● If the CLEAN indicator does not light up, it is time for parts replacement. Consult with us (See the contact information on the back cover).	Back cover

## Others

Trouble	Please check	Ref. Page
Water is leaking from the plumbing connections	● If any nuts in a connection are loose, firmly tighten them with a tool such as a monkey wrench. → If the water leak does not stop, close the shutoff valve and seek repair.	-
The display on the remote control goes out	● The display goes out when no button on the remote control is pressed for 5 minutes or more.	14
The main unit is unstable	● There is clearance between the toilet seat cushion and the toilet bowl for activating the seat switch. When you sit on the toilet seat, the toilet seat subsides slightly to activate the seat switch.	11
The main unit makes a sound	<When the toilet seat is occupied> ● You hear an operation sound at intervals of a few seconds when the cleaning feature is working properly.	-
	<When moving away from the toilet bowl after use> ● You hear the sound of the remaining water being drained from the inside of the product. ● You may hear the fan ventilating the unit. (About 30 minutes)	
	<When not using the product> ● When the cleaning feature is not used for about 8 hours, you may hear the sound of auto wand cleaning.	20



# Specifications

Item		TCF403EG/EGE/ESW	TCF403EG V1	TCF403G/GE/SW
Rated power supply		AC 220 - 240V, 50Hz		
Rated power consumption		845 - 855W		
Maximum power consumption		1528 W (When the water supply temperature is (0 °C))		
Type		Instantaneous		
Power cord length		0.82m	0.6m	1.2m
Water protection level		IPX4		
Functions	Cleansing	Spray volume	Rear cleansing	Approx. 0.27L to 0.43L/min.
			Rear soft cleansing	Approx. 0.27L to 0.43L/min.
			Front cleansing	Approx. 0.29L to 0.43L/min.
		Water temperature	Adjustable temperature range: OFF, about 30°C to 40°C	
		Heater capacity	1200 - 1428W	
		Safety device	Temperature fuse	
		Backflow prevention device	Vacuum breaker, Air gap according to EN1717	
	Warm air dryer	Warm air temperature *	Adjustable temperature range : About 35°C to 55°C	
		Airflow volume	Approx. 0.29m <sup>3</sup> /min.	
		Heater capacity	200 - 238W	
		Safety device	Temperature fuse	
	Heated seat	Surface temperature	Adjustable temperature range: OFF, about 28°C to 36°C (About 26°C when auto energy saver is in operation)	
		Heater capacity	55 - 65W	
		Safety device	Temperature fuse	
	Deodorizer	Method	O <sub>2</sub> deodorization	
		Airflow volume	Approx. 0.16 m <sup>3</sup> /min.	
		Power consumption	Approx. 5.3W	
Water supply pressure		Minimum required water pressure: 0.1MPa (dynamic), Maximum required water pressure: 1.0MPa (static)		
Water supply temperature		0°C to 35°C		
Working ambient temperature		0°C to 40°C		
Dimensions		W 392mm x D 575mm x H 134mm		
Weight		About 7kg		

\* Temperature around the warm air outlet measured by TOTO.

# Warranty

## LIMITED TWO YEARS WARRANTY

1. TOTO warrants its products to be free from manufacturing defects under normal use and service for a period of two (2) years from the date of purchase. This warranty is extended only to the ORIGINAL PURCHASER.
2. TOTO's obligations under this warranty are limited to repair or replacement, at TOTO's option, of products or parts found to be defective, provided that such products were properly installed and used in accordance with this OWNER'S MANUAL. TOTO reserves the right to make such inspections as may be necessary to determine the cause of the defect. TOTO will not charge for labour or parts in connection with warranty repairs or replacements.  
**TOTO is not responsible for the cost of removal, return and/or reinstallation of products.**
3. This warranty does not apply to the following items:
  - a) Damage or loss sustained in a natural calamity such as fire, earthquake, flood, thunder, electrical storm, etc.
  - b) Damage or loss resulting from any unreasonable use, misuse, abuse, negligence, or improper maintenance of the product.
  - c) Damage or loss resulting from removal, improper repair, or modification of the product.
  - d) Damage or loss resulting from sediments or foreign matter contained in a water system.
  - e) Damage or loss resulting from the quality of water in the region where the product is used.
  - f) Damage or loss resulting from improper installation or from installation of a unit in a harsh and/or hazardous environment.
4. This warranty gives you specific legal rights. You may have other rights which vary from country to country.
5. To obtain warranty repair service under this warranty, you must take the product or deliver it prepaid to a TOTO service facility, together with a letter stating the problem, or contact a TOTO distributor or product service contractor, or directly to a TOTO sales office. If, because of the size of the product or nature of the defect, the product cannot be returned to TOTO, receipt by TOTO of a written notice of the defect shall constitute delivery. In such case, TOTO may choose to repair the product at the purchaser's location or pay to transport the product to a service facility.

This written warranty is the only warranty made by TOTO. Repair or replacement as provided under this warranty shall be the exclusive remedy available to the purchaser. TOTO shall not be responsible for loss of use of the product or for other incidental, special, or consequential damage or expenses incurred by the purchaser, or for labour or other costs due to installation or removal, or costs of repairs by others, or for any other expense not specifically stated above. Except to the extent prohibited by applicable law, any implied warranties, including that of merchantability or fitness for use, are expressly limited to the duration of this warranty. Some nations do not allow limitations on how long an implied warranty lasts, or the exclusion or limitation of incidental or consequential damage, so the above limitation and exclusion may not apply to you.

# Important User Guidance Information



If you want to dispose this product, do not mix it with general household waste. There is a separate collection system for used electronic products in accordance with legislation that requires proper treatment, recovery and recycling.

Private households in the member states of the EU, Switzerland and Norway may return their used electronic products free of charge to designated collection facilities or to a retailer (if you purchase a similar new one).

For countries not mentioned above, please contact your local authorities for the correct method of disposal.

By doing so you will ensure that your disposed product undergoes the necessary treatment, recovery and recycling, which prevent potential negative effects on the environment and human health.

Only discard discharged batteries. They should not be disposed of with household waste, but rather at appropriate collection sites or at the product retailer.

# TOTO

## Head Office

TOTO Europe GmbH  
Zollhof 2, 40221 Düsseldorf Germany  
Tel:+49 (0)700 8686 0700

You are advised to record the following information to allow quick service.

Date of purchase :	Name of shop :
Date : year month day	Tel :